

MGate-4101-MB-PBS Modbus Serial-to-PROFIBUS Slave Gateway User's Manual

First Edition, October 2011

www.moxa.com/product



© 2011 Moxa Inc. All rights reserved.

MGate-4101-MB-PBS Modbus Serial-to-PROFIBUS Slave Gateway User's Manual

The software described in this manual is furnished under a license agreement and may be used only in accordance with the terms of that agreement.

Copyright Notice

© 2011 Moxa Inc. All rights reserved.

Trademarks

The MOXA logo is a registered trademark of Moxa Inc.
All other trademarks or registered marks in this manual belong to their respective manufacturers.

Disclaimer

Information in this document is subject to change without notice and does not represent a commitment on the part of Moxa.

Moxa provides this document as is, without warranty of any kind, either expressed or implied, including, but not limited to, its particular purpose. Moxa reserves the right to make improvements and/or changes to this manual, or to the products and/or the programs described in this manual, at any time.

Information provided in this manual is intended to be accurate and reliable. However, Moxa assumes no responsibility for its use, or for any infringements on the rights of third parties that may result from its use.

This product might include unintentional technical or typographical errors. Changes are periodically made to the information herein to correct such errors, and these changes are incorporated into new editions of the publication.

Technical Support Contact Information

www.moxa.com/support

Moxa Americas

Toll-free: 1-888-669-2872
Tel: +1-714-528-6777
Fax: +1-714-528-6778

Moxa Europe

Tel: +49-89-3 70 03 99-0
Fax: +49-89-3 70 03 99-99

Moxa China (Shanghai office)

Toll-free: 800-820-5036
Tel: +86-21-5258-9955
Fax: +86-21-5258-5505

Moxa Asia-Pacific

Tel: +886-2-8919-1230
Fax: +886-2-8919-1231

Table of Contents

1. Introduction	1-1
Overview	1-2
Package Checklist	1-2
Product Features	1-2
2. Getting Started	2-1
Connecting Power	2-2
Connecting PROFIBUS Devices	2-2
Connecting Modbus Serial Devices	2-2
Connecting to a Host via Serial Console Cable	2-2
3. Hardware	3-1
Function Block	3-2
Power Input and Relay Output Pinouts	3-2
LED Indicators	3-2
Dimensions	3-3
Pin Assignments	3-3
Mounting the Unit	3-4
Specifications	3-5
Adjustable Pull High/Low Resistors for the Modbus Port (P1) in RS-485 Mode	3-6
Reset Button	3-6
Rotary Switch	3-7
4. Configuration	4-1
Installing the Software	4-2
Starting MGate Manager	4-6
Connecting to the Unit	4-7
Modifying the Configuration	4-10
Configure Device	4-11
Configure Modbus Settings	4-12
Set up PROFIBUS	4-13
IO Mapping Setup	4-14
QuickLink	4-17
IO Map	4-19
Load Default	4-22
Monitoring Modbus Activity	4-23
Diagnose	4-26
Upgrading Firmware	4-28
Import/Export	4-29
A. Quick Configuration	A-1
Typical Applications	A-2
Quick Configuration Steps	A-3
PROFIBUS Overview	A-3
Modbus Overview	A-4
Diagnose Packet Format	A-6

1

Introduction

Welcome to the MGate 4101-MB-PBS line of Modbus to PROFIBUS gateways. All models feature easy protocol conversion from Modbus to PROFIBUS, and RS-232/422/485 port for Modbus communication.

This chapter is an introduction to the MGate 4101-MB-PBS and includes the following sections:

- **Overview**
- **Package Checklist**
- **Product Features**

Overview

The MGate 4101-MB-PBS is a line of protocol gateways that provides users with the following features:

Protocol conversion between Modbus and PROFIBUS

MGate 4101-MB-PBS series products can be used to connect Modbus devices and PROFIBUS devices to provide PLCs (ex. Siemens S400, S300) with remote maintenance capability.

Windows utilities for easy setup and traffic monitoring

A Windows utility is provided to make configuration and operation of the MGate 4101-MB-PBS as easy as possible. The utility uses serial console port to connect MGate 4101-MB-PBS unit. Besides, Wizard functions can help you finish configuration in only several minutes by automatic commands detection and automatic memory mapping.

Package Checklist

All models of the MGate 4101-MB-PBS series are shipped with the following items:

Standard Accessories:

- 1 MGate 4101-MB-PBS Modbus Serial-to-PROFIBUS Slave Gateway.
- Documentation & Software CD.
- Quick Installation Guide.
- Product warranty statement.
- RJ45 to DB9 cable (for console use)

Optional Accessories:

- DR-4524: 45W/2A DIN-rail 24 VDC power supply with universal 85 to 264 VAC input.
- DR-75-24: 75W/3.2A DIN-rail 24 VDC power supply with universal 85 to 264 VAC input.
- DR-120-24: 120W/5A DIN-rail 24 VDC power supply with 88 to 132 VAC/176 to 264 VAC input by switch.
- WK-36-01: Wall mounting kit

Note: Notify your sales representative if any of the above items is missing or damaged.

Product Features

- Automatic Windows configuration utility.
- Redundant dual DC power inputs
- Enhanced surge protection for serial and power
- 2 KV isolation for serial signals
- PROFIBUS connector to connect the gateway to the field bus
- Power-off warning by relay output
- Software-selectable RS-232/422/485 communication.

2

Getting Started

The following topics are covered in this chapter:

- ❑ **Connecting Power**
- ❑ **Connecting PROFIBUS Devices**
- ❑ **Connecting Modbus Serial Devices**
- ❑ **Connecting to a Host via Serial Console Cable**

Connecting Power

The unit can be powered using the AC adaptor or by connecting a power source to the terminal block, depending on the model. The following instructions are for the AC adaptor:

1. Plug the connector of the power adapter into the DC-IN jack on the back of the unit.
2. Plug the power adapter into an electrical outlet.

Follow these instructions to connect a power source to the terminal block:

1. Loosen or remove the screws on the terminal block.
2. Connect the 12–48 VDC power line to the terminal block.
3. Tighten the connections using the screws on the terminal block.

Note that the unit does not have an on/off switch. It automatically turns on when it receives power. The PWR LED on the top panel will glow to indicate that the unit is receiving power. For power terminal block pin assignments, please refer to the hardware reference chapter for your model.

Connecting PROFIBUS Devices

The unit's PROFIBUS port(s) are located on the front panel. Use a PROFIBUS cable to directly connect the unit to a PROFIBUS PLC or other PROFIBUS master.

For the PROFIBUS port pin assignments, please refer to Chapter 3. This information can then be used to construct your own PROFIBUS cable.

Connecting Modbus Serial Devices

The unit's Modbus port(s) are located on the front panel. Use a Modbus cable to directly connect the unit to a Modbus RTU/ASCII device.

For the Modbus port pin assignments, please refer to Chapter 3. This information can then be used to construct your own Modbus cable.

Connecting to a Host via Serial Console Cable

A RS-232 serial console port is located on the unit's front panel. This port is used for console configuration via a *CBL-RJ45-M9-150* RJ-45-to-DB9 cable.

For normal operation, use a standard straight-through RS-232 serial cable to connect the unit to your COM port. You connect the unit directly to a PC. Besides, use a serial cable to connect the unit to your PC's serial connector.

The Tx/Rx LED of the console port will light up to indicate serial connection status when data is communicated with each other.

3

Hardware

The following topics are covered in this chapter:

- ❑ **Function Block**
- ❑ **Power Input and Relay Output Pinouts**
- ❑ **LED Indicators**
- ❑ **Dimensions**
- ❑ **Pin Assignments**
- ❑ **Mounting the Unit**
- ❑ **Specifications**
- ❑ **Adjustable Pull High/Low Resistors for the Modbus Port (P1) in RS-485 Mode**
- ❑ **Reset Button**
- ❑ **Rotary Switch**

Function Block

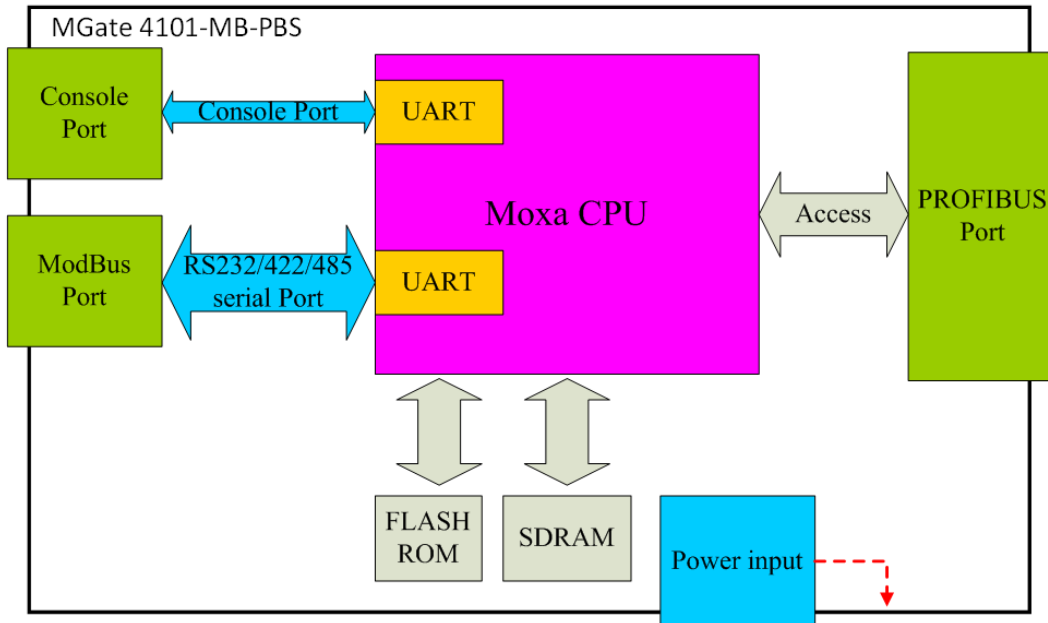

Power Input and Relay Output Pinouts

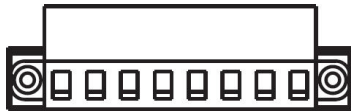

	V2+	V2-			V1+	V1-
Shielded Ground	DC Power Input 2	DC Power Input 2	Relay output	Common	DC Power Input 1	DC Power Input 1

LED Indicators

LED	Color	Function
PWR1	Green	Power is on.
	Off	Power is off.
PWR2	Green	Power is on.
	Off	Power is off.
Ready	Green	Gateway is operational.
	Red	Gateway has wrong settings.
	Off	Power is off or fault condition exists.
P1 Tx/Rx (Modbus Serial)	Green	Serial device is transmitting data.
	Orange	Serial device is receiving data.
	Off	No data is flowing to or from the serial port.
P2 Status (PROFIBUS)	Green	Steady: Gateway is waiting for data exchanging. Blinking: Data is exchanging.

	Orange	Steady: Error in Configuration. Blinking: Error in Parameter data
	Off	PROFIBUS offline or Slave ID wrong.

Dimensions

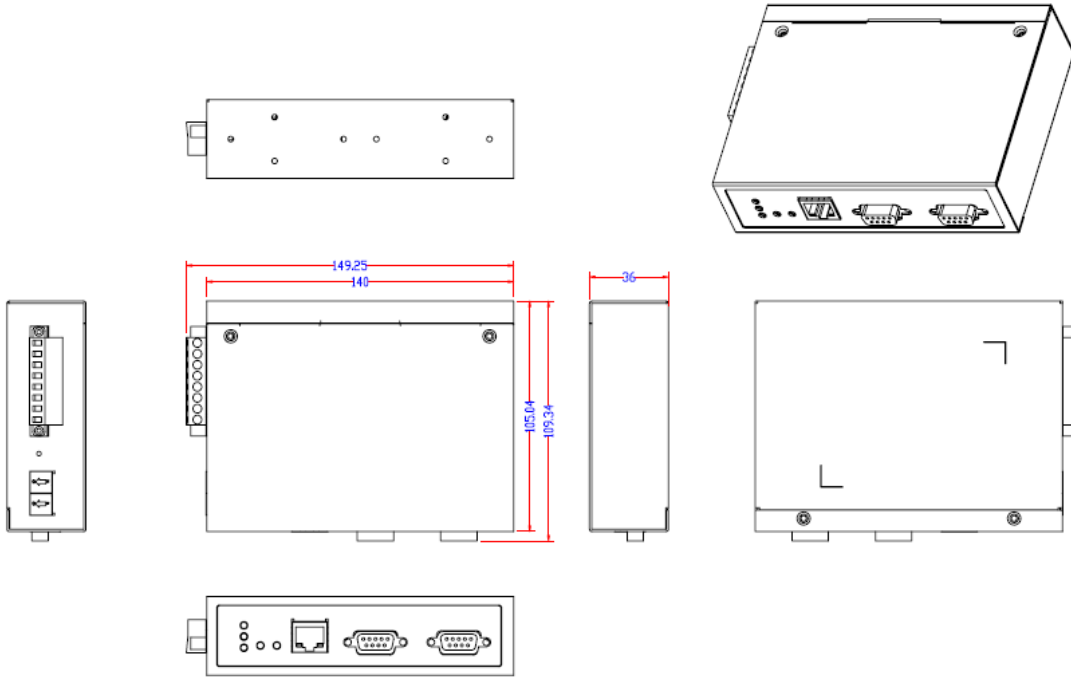

Pin Assignments

Modbus P1 Pin Assignment

The MGate 4101-MB-PBS series use DB9 (male) serial port to connect to Modbus devices.

Pin	RS-232	RS-422/ RS-485 (4W)	RS-485 (2W)
1	DCD	TxD-(A)	---
2	RXD	TxD+(B)	---
3	TXD	RxD+(B)	Data+(B)
4	DTR	RxD-(A)	Data-(A)
5	GND	GND	GND
6	DSR	---	---
7	RTS	---	---
8	CTS	---	---
9	---	---	---

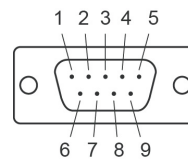

PROFIBUS P2 Pin Assignment

The MGate 4101-MB-PBS series use DB9 (female) serial port to connect to PROFIBUS devices.

PIN	Signal Name
1	N.C.
2	N.C.
3	PROFIBUS D+
4	RTS
5	Signal common

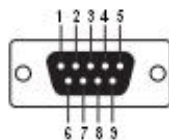

6	5V
7	N.C.
8	PROFIBUS D-
9	N.C.

Console (RS-232) Pin Assignment

The MGate 4101-MB-PBS series use RJ45 serial port to connect to PC to configure device.

PIN	RS-232
1	DTR
2	RTS
3	GND
4	TXD
5	RXD
6	DCD
7	CTS
8	DTR

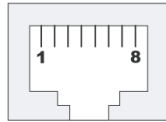

Mounting the Unit

The unit can be mounted on the wall or mounted on a DIN-Rail. The MGate 4101-MB-PBS/4101I-MB-PBS series is designed to be attached to a DIN-Rail or mounted on a wall. For DIN-Rail mounting, push down the spring and properly attach it to the DIN-Rail until it “snaps” into place. For wall mounting, install the wall mount kit (optional) first, and then screw the device onto the wall. The following figure illustrates the two mounting options:

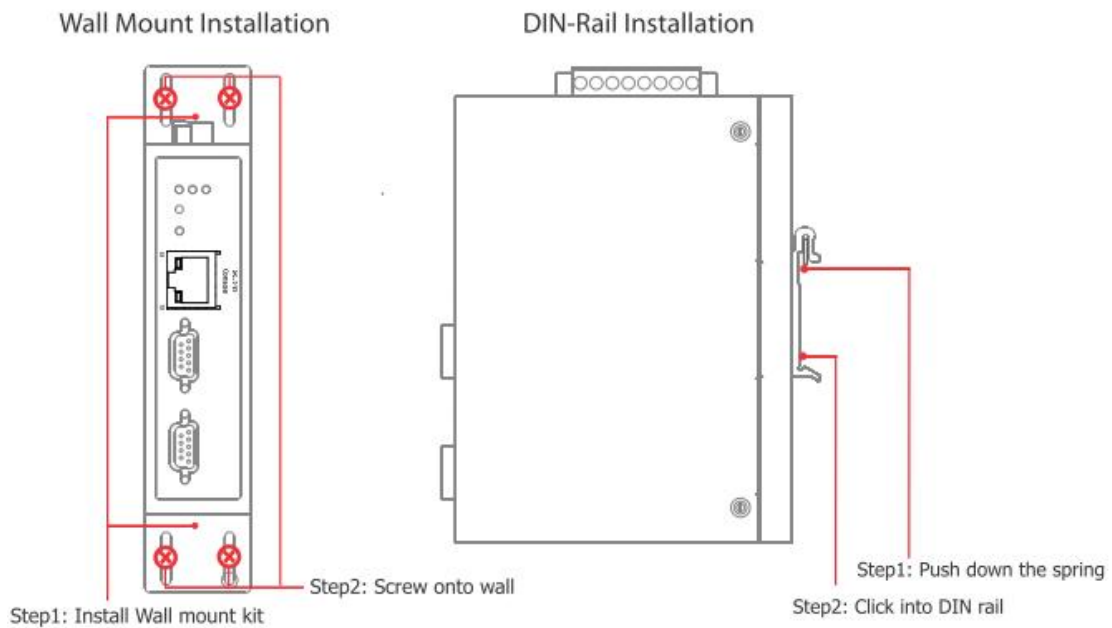

Specifications

Power Input

Input Voltage	12 to 48 VDC
Connector	8-pin terminal block (GND, V1+, V1-, Relay NC, Relay NC, V2+, V2-), screw mounting

Modbus Serial Interface

Protocol	Modbus ASCII/RTU, Master/Slave
Number of Ports	1
Serial Standards	RS-232/422/485, software selectable
Data Bits	7, 8
Stop Bits	1, 2
Parity	None, Even, Odd, Space, Mark
Flow Control	RTS/CTS, XON/XOFF
Baudrate	50 bps to 921.6 Kbps
Connector	DB9 male
Serial Line Protection	
ESD	15KV protection for all signals
Isolation	2KV protection (MGate 4101I-MB-PBS only)
RS-485 Data Direction Control	ADDC® (automatic data direction control)
Pull High/Low Resistor for RS-485	1 K Ω , 150 K Ω (switchable)
Terminal Resistor	120 Ω for RS-485
Modbus Function	1,2,3,4,5,6,15,16

Modbus Serial Signals

RS-232	TxD, RxD, RTS, CTS, DTR, DSR, DCD, GND
RS-422	Tx+, Tx-, Rx+, Rx-, GND
RS-485-4w	Tx+, Tx-, Rx+, Rx-, GND
RS-485-2w	Data+, Data-, GND

PROFIBUS Interface

Protocol	PROFIBUS DP-V0 Slave
Data rate	9600 bit/s, 19.2, 93.75, 187.5, 500 kbit/s, 1.5, 3, 6 and 12 Mbit/s
Connector	DB9 female
Isolation	Built-in 2 KV
DIP Switch	for Termination
Rotary Switch	PROFIBUS address 0~99 (address 100~125 supported by SW)

Console Interface RJ45 to DB9 cable

Utility

Driver Support	Windows 2000/XP/2003/Vista/2008/7 x86/x64
----------------	---

Physical Characteristics

Housing	Metal, IP30 protection
Dimensions	36 x 105 x 140 mm (1.42 x 4.13 x 5.51 in)

Environmental Limits

Operating Temperature	
Standard Temp. Models	0 to 60°C (32 to 140°F)
Wide Temp. Models	-40 to 75°C (-40 to 167°F)
Operating Humidity	5 to 95% RH
Storage Temperature	-40 to 85°C (-40 to 185°F)

Regulatory Approvals

EMC	CE (EN55022 Class A, EN55024), FCC Part 15 Subpart B Class A
Safety	UL (UL60950-1), LVD (EN60950-1)

Reliability

Alert Tools	Built-in buzzer and RTC (real-time clock)
MTBF	513,139 hours

Warranty

5 years

Adjustable Pull High/Low Resistors for the Modbus Port (P1) in RS-485 Mode

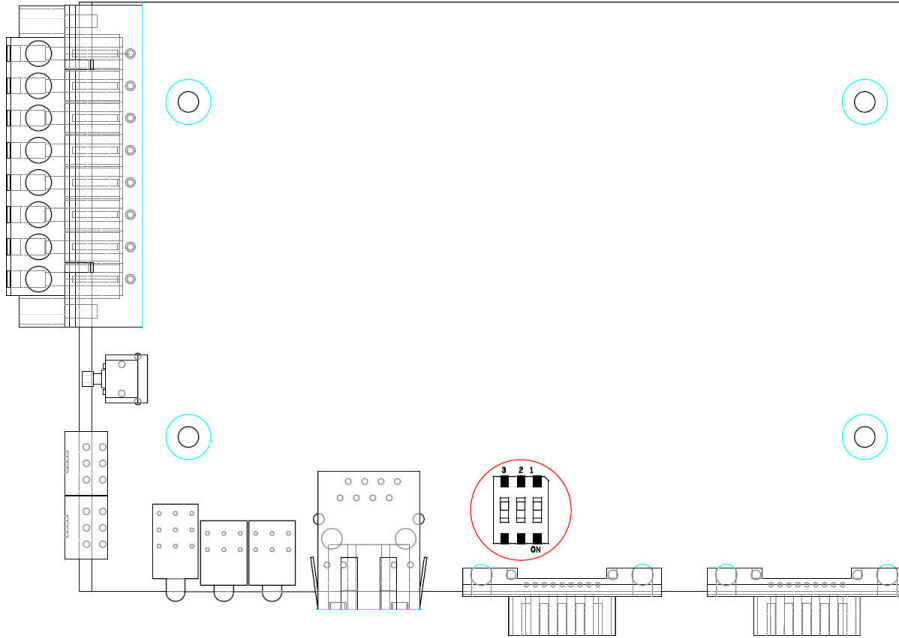

	SW	1	2	3
		Pull High	Pull Low	Terminator
	ON	1KΩ	1KΩ	120Ω
Default	OFF	150Ω	150KΩ	---

In some critical environments, you may need to add termination resistors to prevent the reflection of serial signals. When using termination resistors, it is important to set the pull high/low resistors correctly so that the electrical signal is not corrupted. The MGate uses jumper settings or DIP switches to set the pull high/low resistor values for each serial port.

To set the pull high/low resistors to 150 KΩ, make sure that the two jumpers assigned to the serial port are not shorted by jumper caps. This is the default setting.

To set the pull high/low resistors to 1 KΩ, make sure that the two jumpers assigned to the serial port are shorted by jumper caps.



ATTENTION

Do not use the 1 KΩ setting on the MGate when using the RS-232 interface. Doing so will degrade the RS-232 signals and shorten the maximum allowed communication distance.

Reset Button

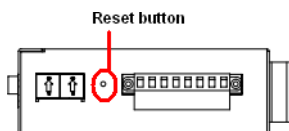

To reset the MGate to the factory default settings, hold down the reset button for about 5 seconds. The MGate will restart and be rest to factory default settings.

Rotary Switch

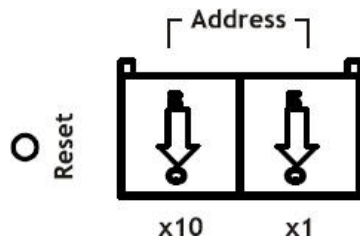

Before communication, you must assign a slave ID to the PROFIBUS slave, If you would like to assign an address between 0 - 99, you need to change the rotary switch to the desired address. If you would like to assign an address which is over 99, you must set it in the MGate utility.

4

Configuration

The following topics are covered in this chapter:

- ❑ **Installing the Software**
- ❑ **Starting MGate Manager**
- ❑ **Connecting to the Unit**
- ❑ **Modifying the Configuration**
 - Configure Device
 - Configure Modbus Settings
 - Set up PROFIBUS
 - IO Mapping Setup
 - QuickLink
 - IO Map
 - Load Default
 - Monitoring Modbus Activity
 - Diagnose
- ❑ **Upgrading Firmware**
- ❑ **Import/Export**

Installing the Software

The following instructions explain how to install MGate Manager, a utility for configuring and monitoring MGate 4101-MB-PBS units over the network.

1. Insert the Document and Software CD into the CD-ROM drive. Locate and run the following setup program to begin the installation process:
MGM_Setup_[Version]_Build_[DateTime].exe
The latest version might be named MGM_Setup_Ver1.5_Build_xxxxxxx.exe.
2. You will be greeted by the Welcome window. Click Next to continue.

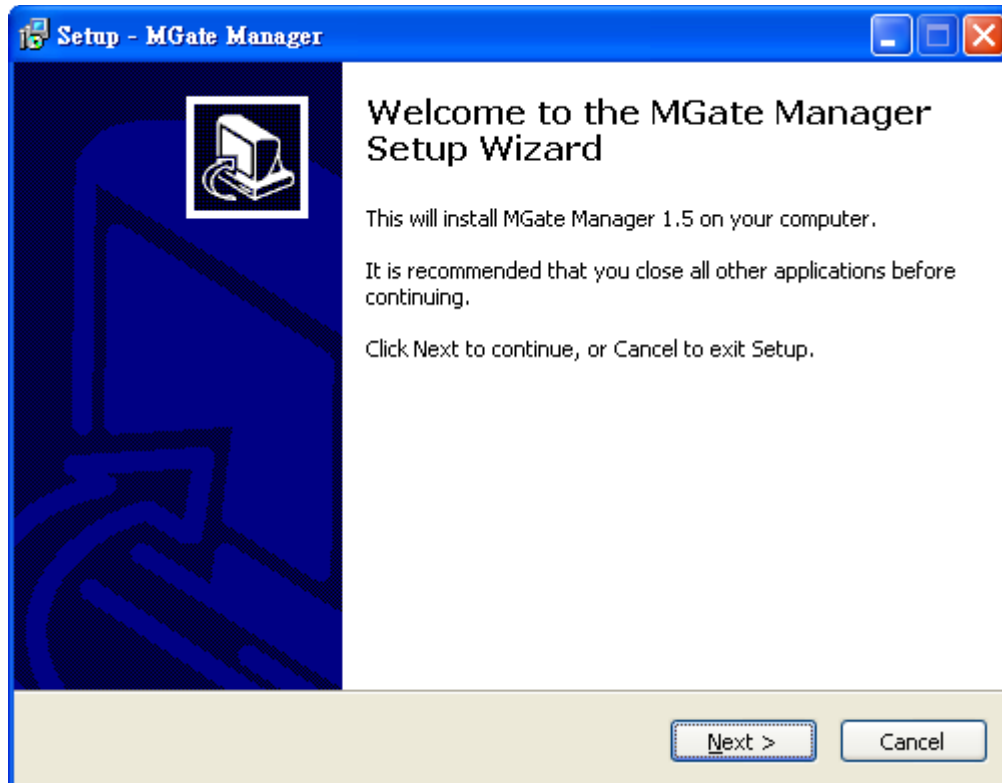

3. When the Select Destination Location window appears, click Next to continue. You may change the destination directory by first clicking on Browse.

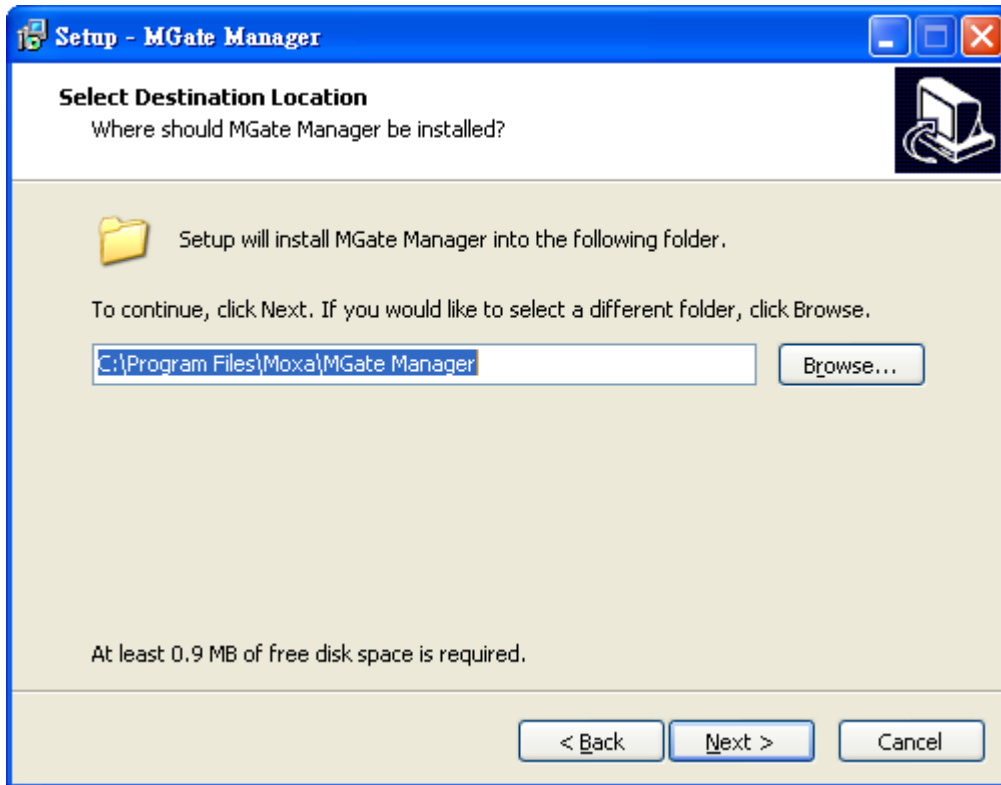

4. When the Select Additional Tasks window appears, click Next to continue. You may select Create a desktop icon if you would like a shortcut to MGate Manager on your desktop.

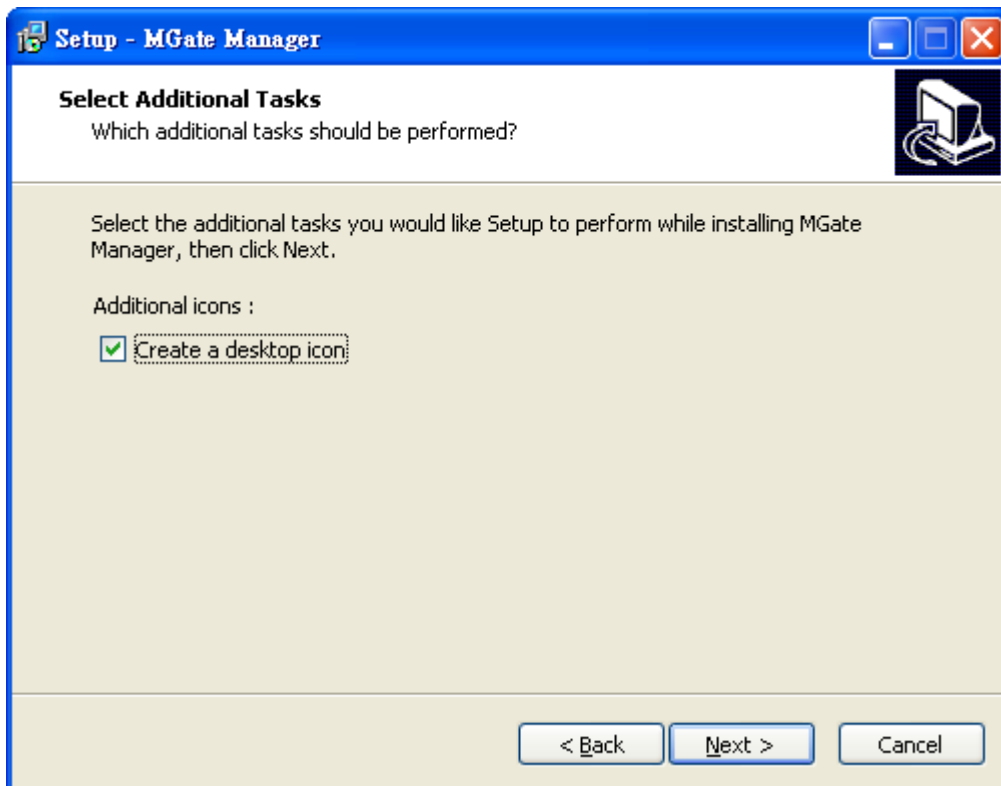

5. Click Next to start copying the software files.

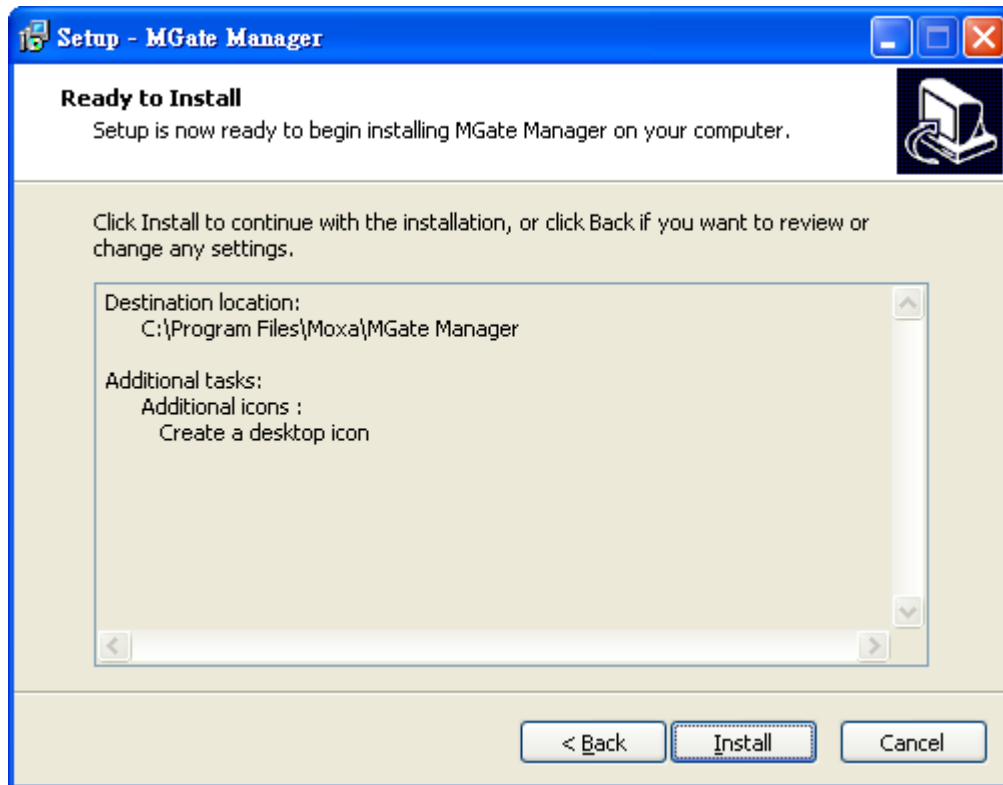

6. A progress bar will appear. The procedure should take only a few seconds to complete.

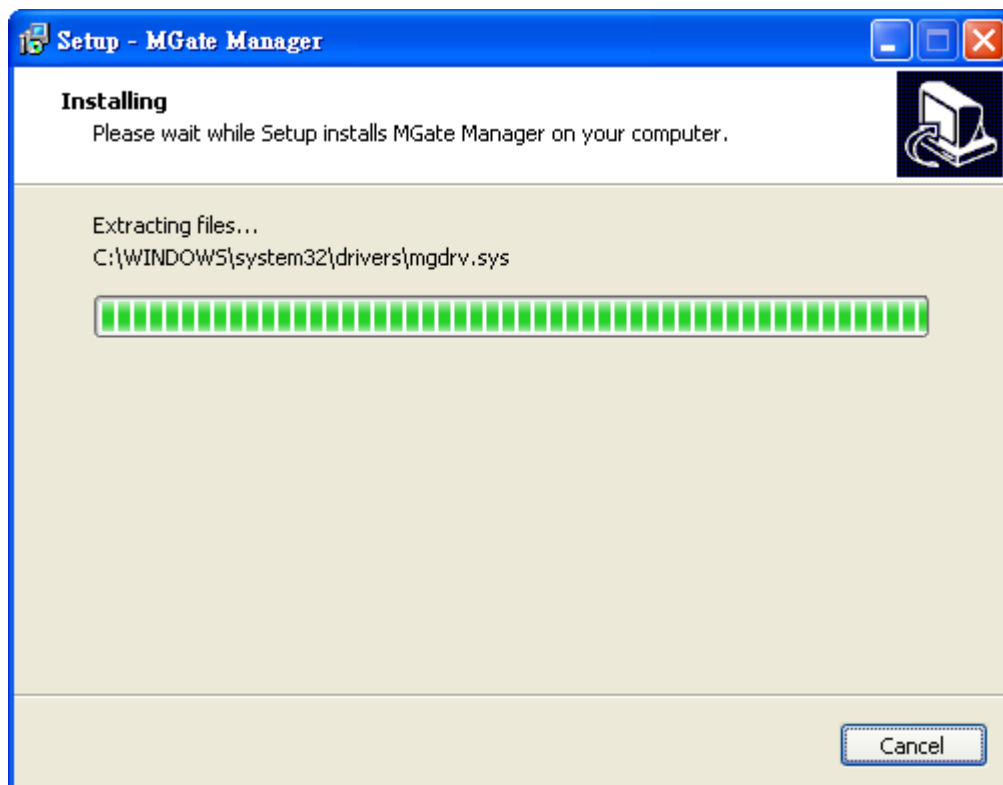

Starting MGate Manager

MGate Manager is a Windows-based utility that is used to configure the MGate 4101-MB-PBS.

Before running MGate Manager, make sure that the MGate 4101-MB-PBS is connected to your PC. Please refer to Chapter 2 for more details.

You may open MGate Manager from the Windows Start menu by clicking **Start → Programs → MGate Manager → MGate Manager**. The MGate Manager window should appear as shown below.

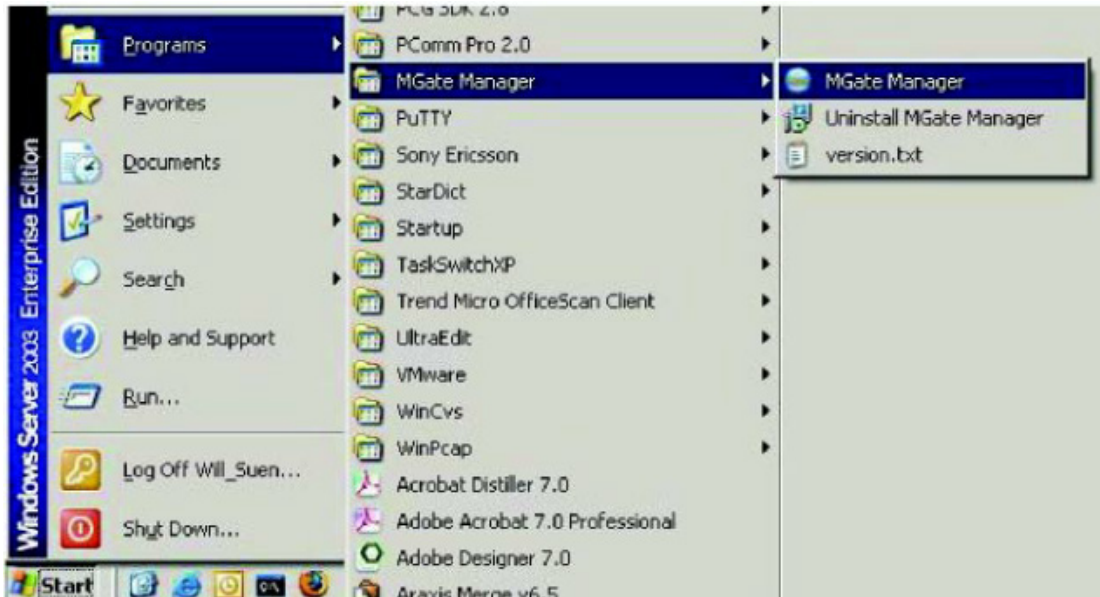

Change Language Setting

If you wish to run MGate Manager in a different language, you may click **Language** to change the language setting. A dialog box showing the available languages should appear as shown below.

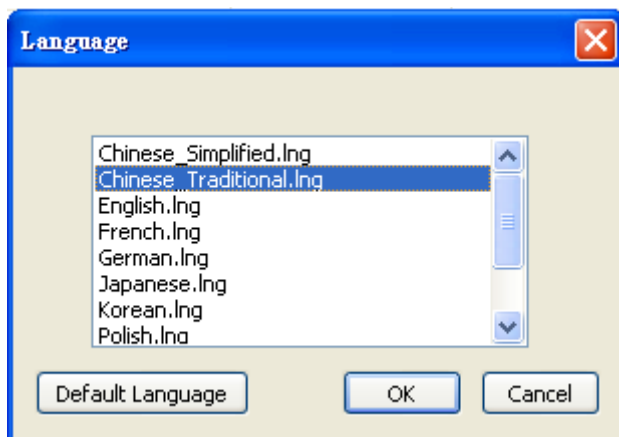

When you click **OK**, MGate Manager will immediately reflect your chosen language.



After changing to a different language, you will find that all strings on MGate Manager are replaced in your chosen language. For example, the above picture is shown in traditional Chinese. However, no matter what language you choose, it won't change the label on the language button.



ATTENTION

Set your MGate Manager to “**Default Language**” before contacting Moxa Technical Support.

With support for multiple languages, MGate Manager is more user-friendly and accessible. However, if you need assistance from Moxa Technical Support, please change the language to “Default Language”. This will prevent any misunderstandings or confusion about MGate Manager menu items and commands as our engineers assist you.

The default language is English and will only be active for the current MGate Manager session. When you open MGate Manager again, the language will revert to your original setting.

Connecting to the Unit

Prior to configuration, MGate Manager must be connected to its unit. There are three methods to establish connection. Broadcast Search locates the MGate series on the LAN and each MGate 4101-MB-PBS connected to a PC COM port. Search by IP attempts to connect to a specific unit by IP address, which is useful if the unit is located outside the LAN or can only be accessed by going through a router. Connect through COM port tries to connect to a separate unit via a RS-232 serial COM port.

Broadcast Search

Broadcast Search is used for MGate Ethernet Gateways, such as the MGate MB3000 and MGate EIP3000 series, which are discovered via Ethernet by using broadcast IP. In addition, whenever you add an MGate 4101-MB-PBS via serial console, the MGate Manager will automatically record the COM port(s) for the broadcast to search as well. Note that restarting the MGate Manager will erase the COM port(s) record.

Specify by IP Address

Specify by IP Address is used for MGate Ethernet Gateways, such as the MGate MB3000 and MGate EIP3000 series, which are discovered via Ethernet by using a specific IP address. Click **Specify by IP Address** if you know the IP address of the unit and wish to connect to it directly.



ATTENTION

If Search by IP Address fails to locate the MGate MB3000 or MGate EIP3000 series, the IP address that you entered might be incorrect. Try doing the search again and re-entering the IP address carefully.

Another possibility is that the MGate MB3000 or MGate EIP3000 series is located on the same LAN as your PC, but on a different subnet. In this case, you can modify your PC's IP address and or netmask so that it is on the same subnet as the MGate MB3000 or MGate EIP3000 series. After your PC and the MGate MB3000 or MGate EIP3000 series are on the same subnet, MGate Manager should be able to find the unit.

Connect through COM Port

Connect through COM Port is used for MGate PROFIBUS Gateways, such as the MGate 4101-MB-PBS series, which are discovered via RS-232 serial COM Port. Click Connect through COM Port if you know the COM port number of the unit.

Search

Click Search to begin searching the serial console for the MGate 4101-MB-PBS units.

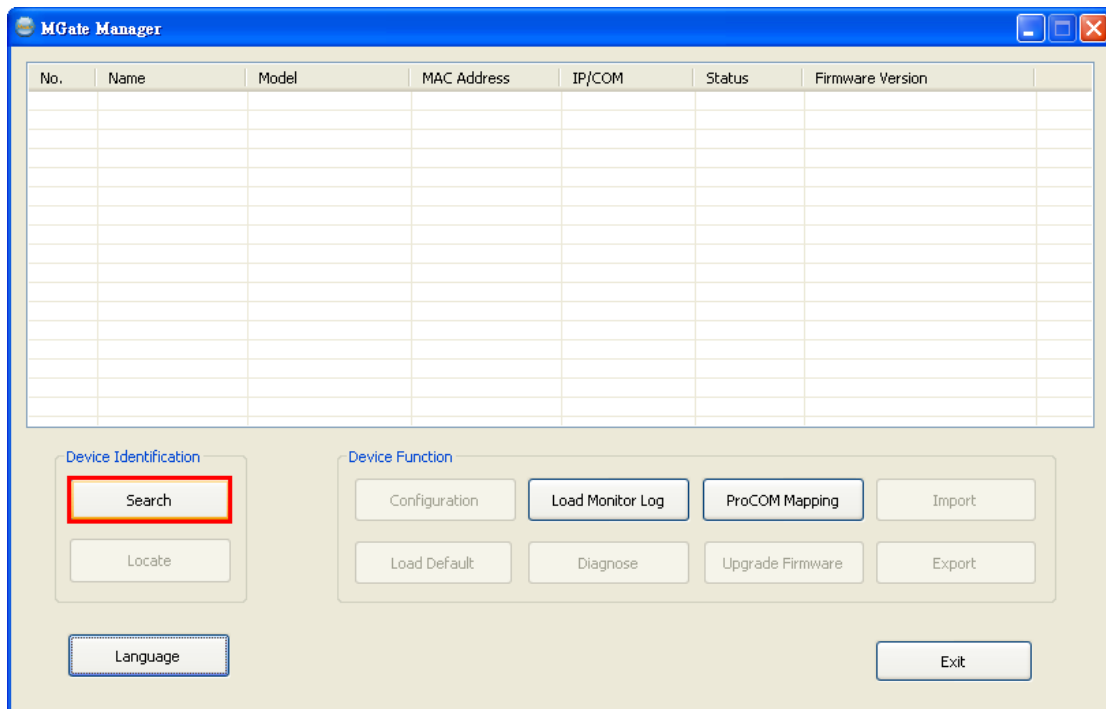

A dialog box will appear. Click **Connect through COM Port** and choose which COM port is used to connect to MGate 4101-MB-PBS.

Configure Device

In first page, you can change device name and select a Password to protect the unit from unauthorized access.

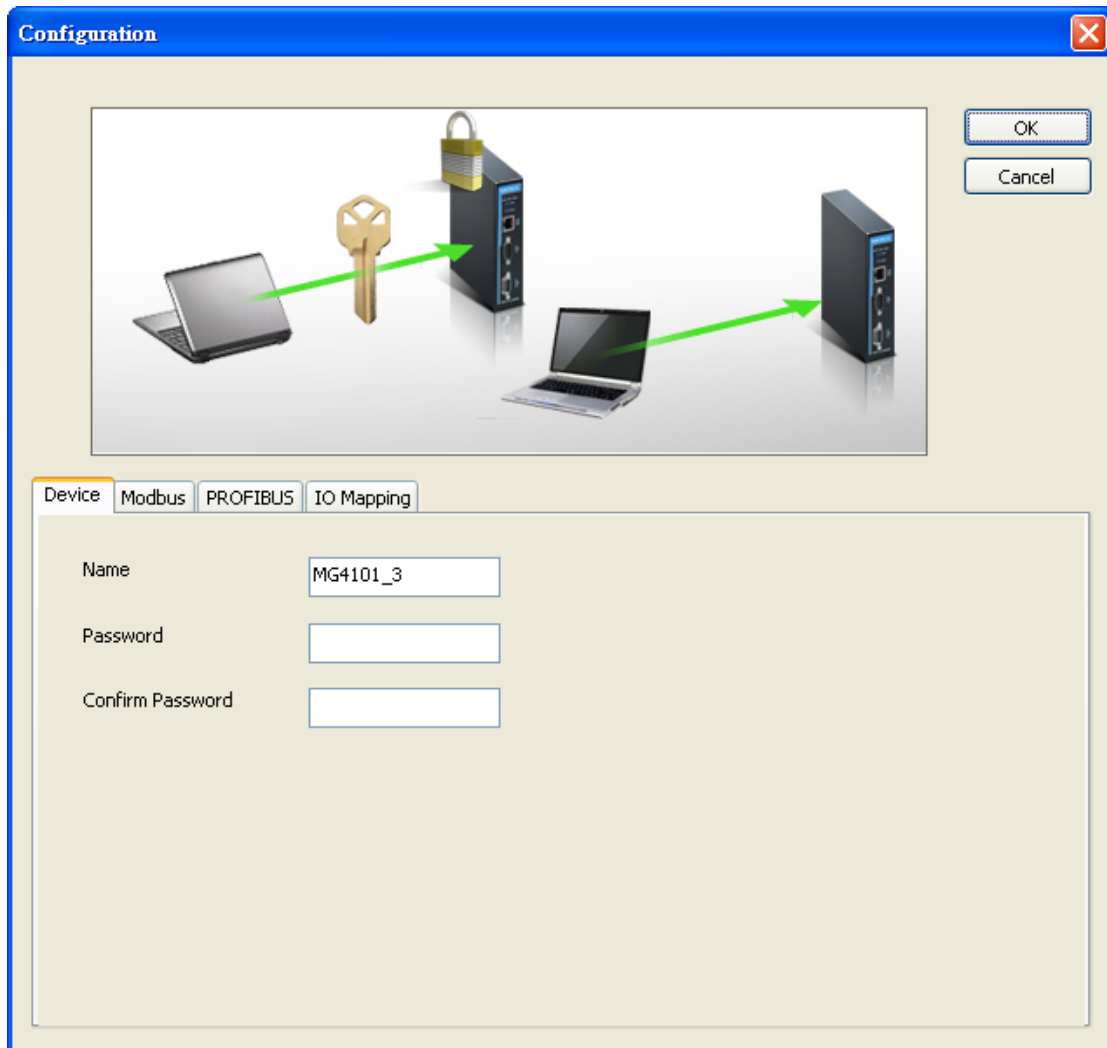

Parameter	Value	Notes
Name	(an alphanumeric string)	You can enter a name to help you identify the unit, such as the location, function, etc.
Password	(an alphanumeric string)	You can set a password to prevent unauthorized users from configuring the unit. The password will be required when anyone attempts to configure the unit over the network. Modbus operation is not affected by the password.
Confirm password	(an alphanumeric string)	Re-type the password again for confirmation.



ATTENTION

To erase an existing password, leave both the New Password and Confirm Password text input boxes blank. The password will be erased when you click OK in the bottom right corner.

Configure Modbus Settings

The Serial tab is where Modbus serial port’s communication parameters are configured. You can configure Baud Rate, Parity, Stop Bit, Flow Control, FIFO, and Interface Mode.

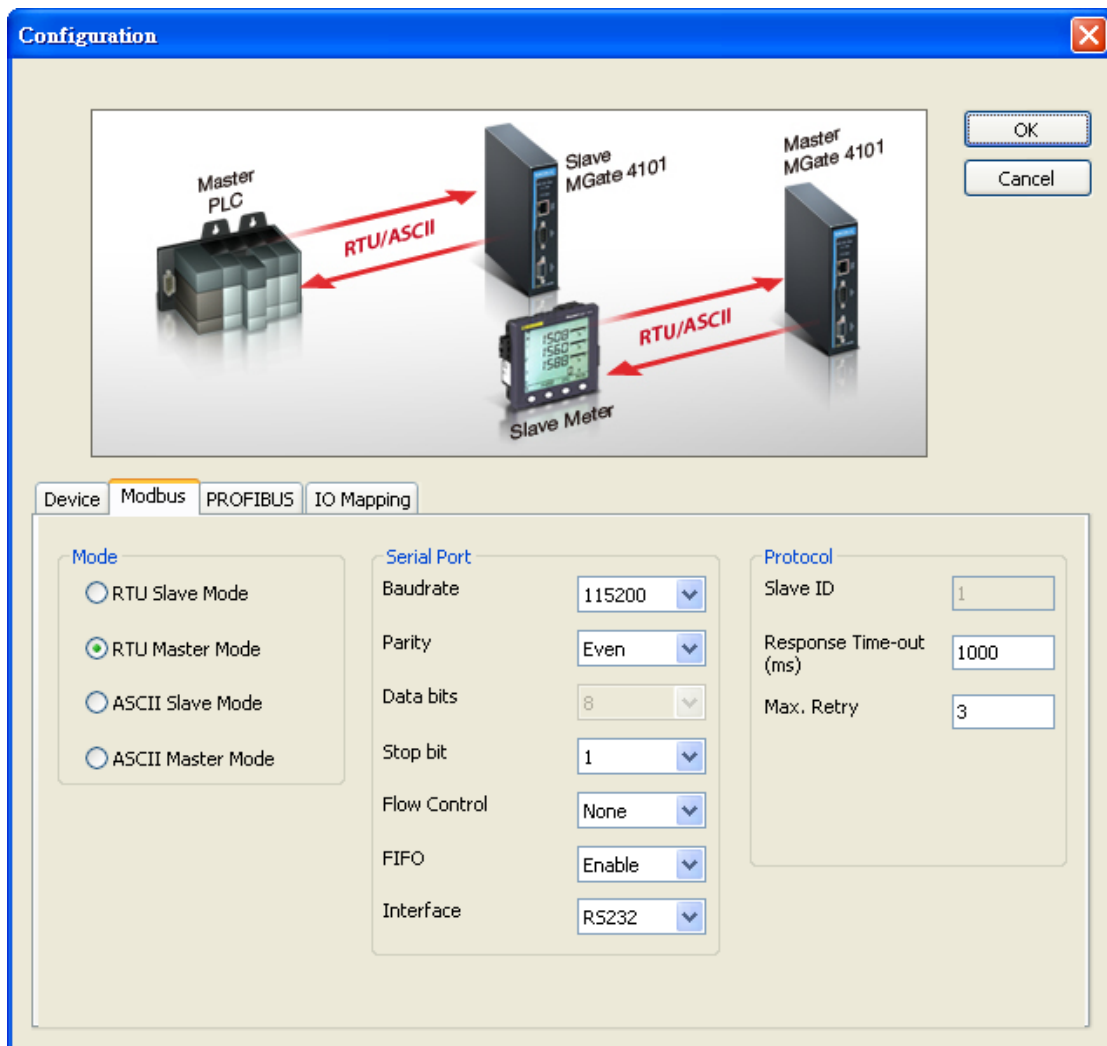

Mode	Description
RTU Master	Modbus RTU slave(s) will be connected to the serial port
RTU Slave	A Modbus RTU master will be connected to the serial port
ASCII Master	Modbus ASCII slave(s) will be connected to the serial port
ASCII Slave	A Modbus ASCII master will be connected to the serial port

Serial Port	Description
Baud Rate	1200 bps to 961200 bps
Parity	None, Odd, Even
Data Bits	8
Stop Bits	1, 2
Flow Control	None, DTR/DSR, RTS/CTS
FIFO	Enable, Disable
Interface	RS-232, RS-422, RS-485

Protocol	Description
Slave ID	Slave mode only, Modbus slave identification number of the MGate 4101-MB-PBS
Response Time-out (ms)	Master mode only, the time master will wait for a response after sending a request. See detailed description below.

Max. Retry	Master mode only, the number of times the master will retry the same request when response time out.
------------	--

Response Time-out

According to the Modbus standard, the time that it takes for a slave device to respond to a request is defined by the device manufacturer (please refer to Appendix A of MGate MB3000 series User Manual for details). Based on this response time, a master can be configured to wait a certain amount of time for a slave’s response. If no response is received within the specified time, the master will disregard the request and continue operation. This allows the Modbus system to continue operation even if a slave device is disconnected or faulty.

On the MGate 4101-MB-PBS, the “Response Time-out” field is used to configure how long the gateway will wait for a response from a Modbus ASCII or RTU slave. Please refer to your device manufacturer’s documentation to manually set the response time-out.

Set up PROFIBUS

Every PROFIBUS slave device should be assigned a unique address in the same field. If the address you would assign is lower than 99, please use the rotary switches (decimal) on the top of device. If the address you would assign is higher than 99, please set the rotary switches as 99 and **Slave Address** field will be enabled for setting the designated address.

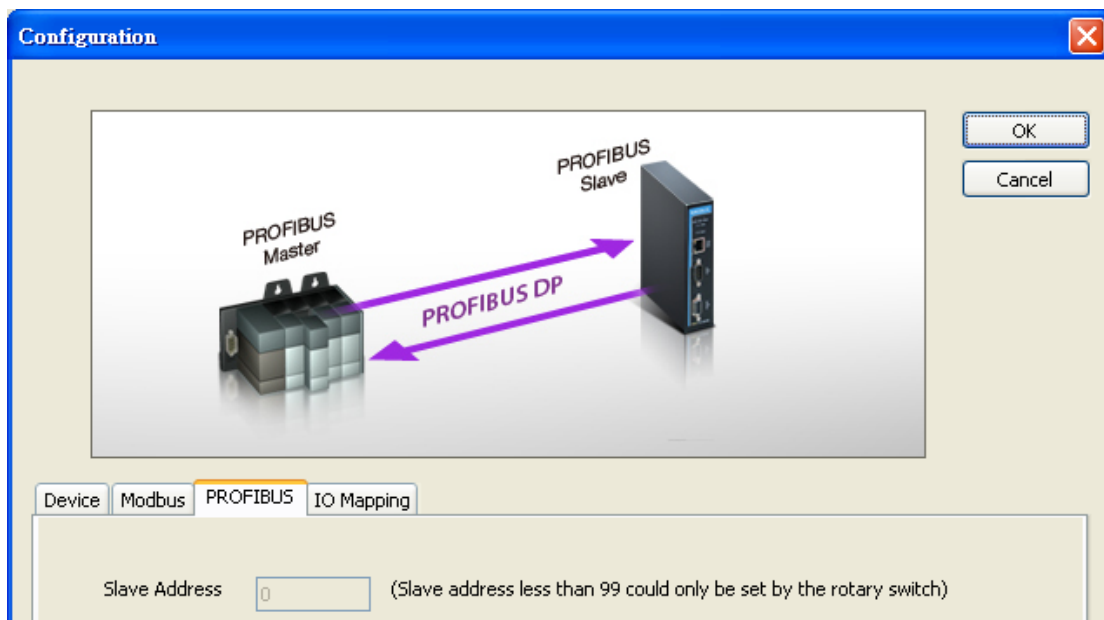

PROFIBUS	Description
Slave Address	Before communication, you must assign a slave ID to the PROFIBUS slave, If you would like to assign an address between 0-99, you need to change the rotary switch to the desired address. If you would like to assign an address which is over 99, you must set it in the MGate utility. If you would like to use a slave address which is over 99, set the rotary switch to “99” and then use MGate Manager to configure the desired address.

Refer to chapter 3 for instructions on how to set the slave address using a rotary switch.

IO Mapping Setup

In this page, you should define all commands that Modbus uses and all I/O modules PROFIBUS slave provides.

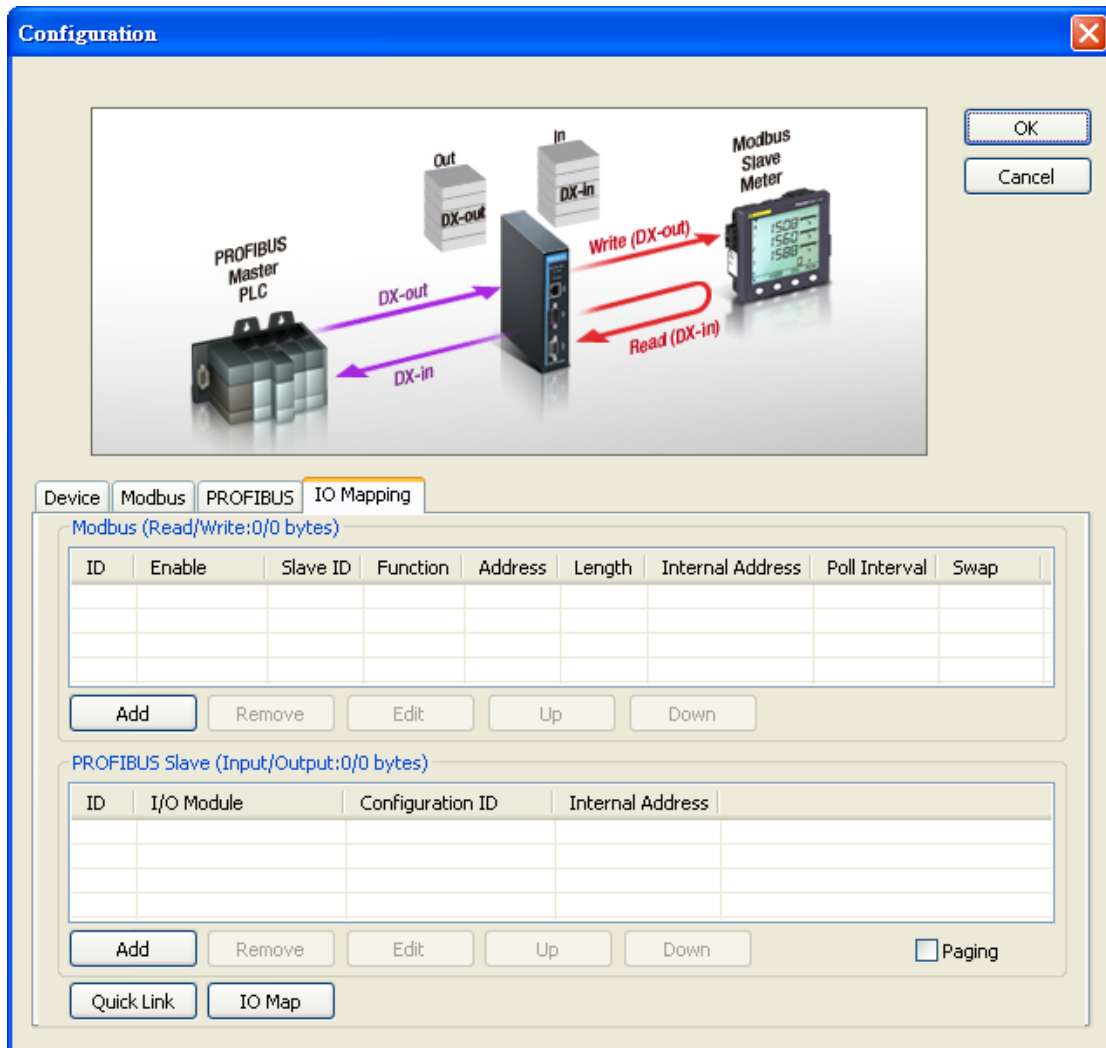

If you choose MGate 4101-MB-PBS as Modbus Master, you should designate all Modbus Read or Write requests in the upper table.

Click **Add** to create each Modbus request.

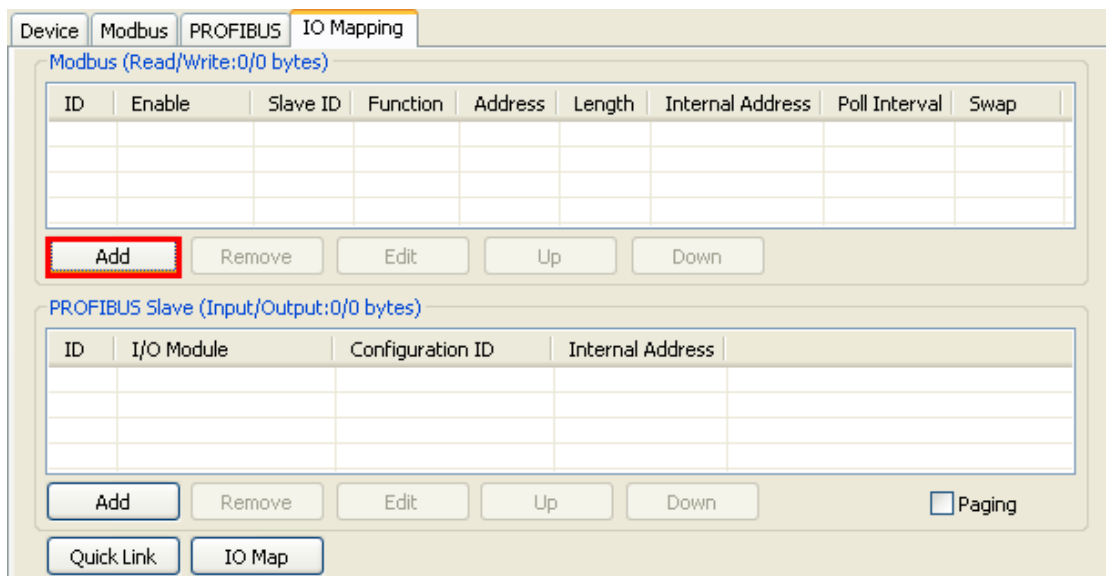

Each Modbus request includes Enable, Modbus slave ID, Function Code, Address, Length, Internal Address, Poll Interval, Swap. Please refer to datasheets or manuals of Modbus slave devices to fill out these fields.

Parameter	Description
Enable	The Enable for the transaction: Disable: The transaction is never sent Cyclic: The transaction is sent cyclically at the interval specified in the "Poll Interval" parameter. Data change: The data area is polled for changes at the time interval defined by Poll Interval. A transaction is issued when a change in data is detected.
Slave ID	The Modbus slave id that this slave module will accept. 0: Broadcasting 1~255: Device specific
Function Code	When a message is sent from a Client to a Server device the function code field tells the server what kind of action to perform. We support the following function code by far: 01: Read coils 02: Read discrete inputs 03: Read holding registers 04: Read input register 05: Write single coil 06: Write single register 15: Write multiple coils 16: Write multiple registers
Address	Station Address. The range is from 0 to 65535
Length	The length field is a byte count of the following fields, including the Unit Identifier and data fields. The range is from 1 to 1953.
Internal Address	This parameter specifies the location of the trigger byte in internal memory. The range is from 0 to 243.
Poll Interval (ms)	Polling interval in millisecond, since the module sends all requests in turns, the actual polling interval also depends on the number of requests in the queue and their parameters. The range is from 500 to 1200000.
Swap	Data Byte Swapping None: Don't need to swap Byte: 0x0A, 0x0B, 0x0C, 0x0D becomes 0x0D, 0x0C, 0x0B, 0x0A. Word: 0x0A, 0x0B, 0x0C, 0x0D becomes 0x0C, 0x0D, 0x0A, 0x0B. ByteWord: 0x0A, 0x0B, 0x0C, 0x0D becomes 0x0D, 0x0C, 0x0B, 0x0A. There are two phases in changing ByteWord 1). 0x0A, 0x0B, 0x0C, 0x0D becomes 0x0B, 0x0A, 0x0D, 0x0C. 2). 0x0B, 0x0A, 0x0D, 0x0C becomes 0x0D, 0x0C, 0x0B, 0x0A.

After all Modbus requests finish, all the data collected from Modbus should be mapped to PROFIBUS I/O modules for the PROFIBUS Master to use.

Click **Add** to create each PROFIBUS I/O module in the lower table.

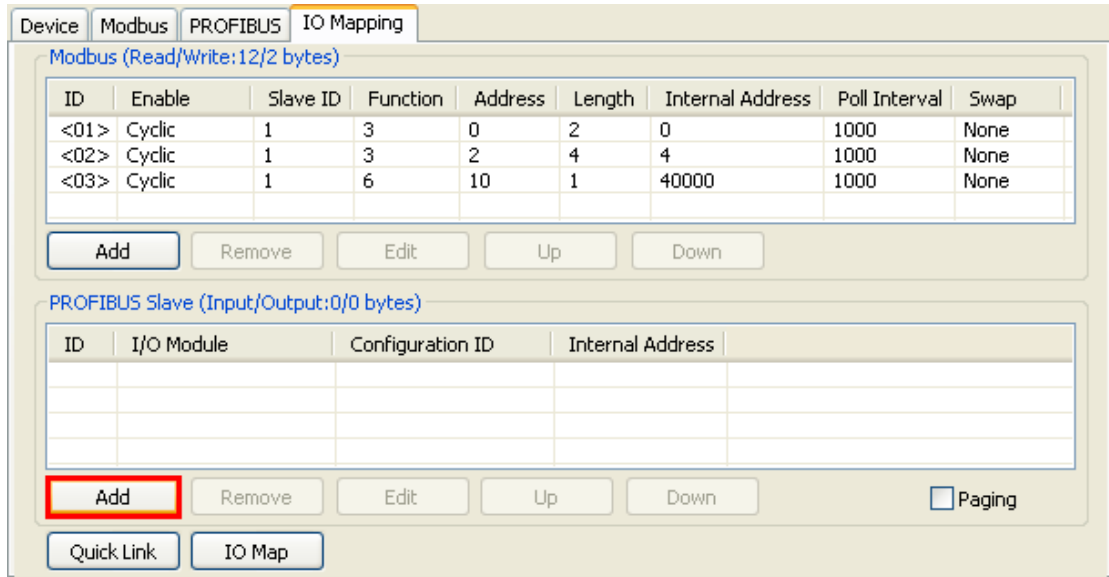

Then, a dialog which is used to set up the IO module will appear, please adjust the parameters which correspond with the Modbus requests you set before. Click **OK** to record this IO module.

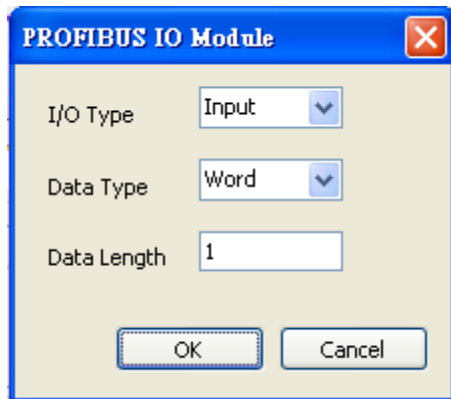

Parameter	Description
I/O Type	Input: Used to map into input memory Output: Used to map into output memory
Data Type	The data type for this IO module
Data Length	The data length for this IO module. The range is from 1 to 64.

Finally, you can see the IO module you configure before is put into PROFIBUS Slave list.

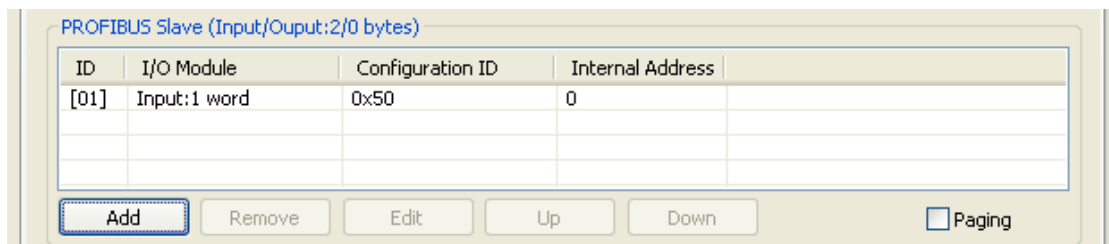

Follow the above steps, you can map all of Modbus requests you need into IO module. In this way, MGate 4101-MB-PBS can communicate between PROFIBUS protocol and Modbus protocol.

NOTE Each "ID" of the commands must be mapped, that is, the commands in Modbus will correspond with the I/O module in PROFIBUS

QuickLink

The QuickLink is an innovative function to let you configure more quickly and easily. Typically, most PROFIBUS users must spend a lot of time to set up Modbus commands in a PROFIBUS application. By using the QuickLink function, the MGate 4101-MB-PBS will learn Modbus requests automatically, to save time in deployment. However, the function is only enabled in Modbus master mode. (Please refer to the Typical Application in the Appendix for more details). Start QuickLink by clicking the **QuickLink** button.

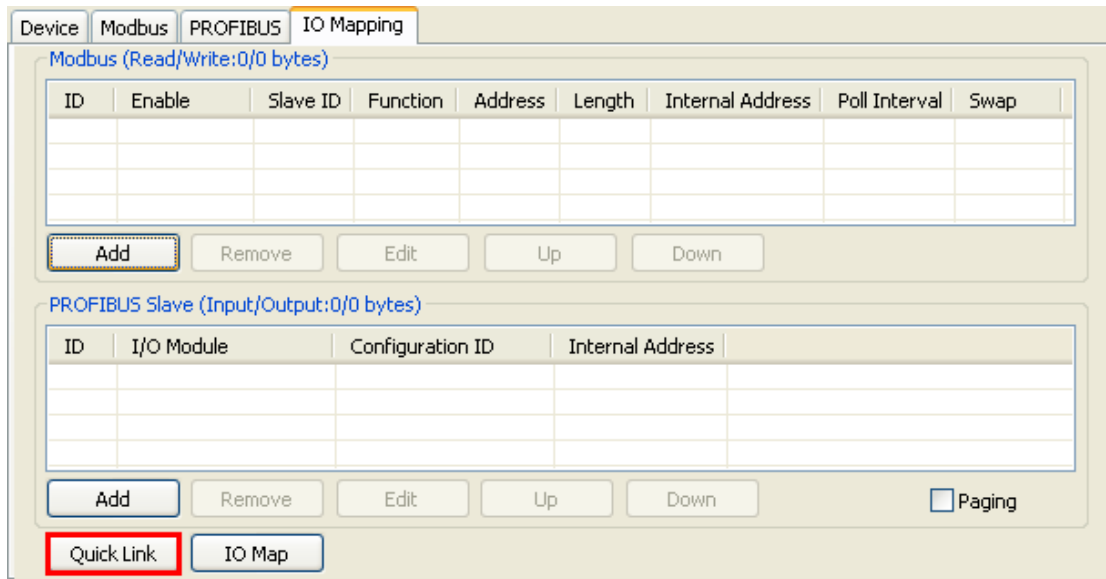

It takes a period of time to learn the Modbus requests. Begin by clicking the **Start** button, which will change the Status to On Learning. The number of Learned Requests will increase as the MGate 4101-MB-PBS learns each request. When you are sure all requests have been learned by the MGate 4101-MB-PBS, click the **Stop** button, then click the **Next** button to continue QuickLink.

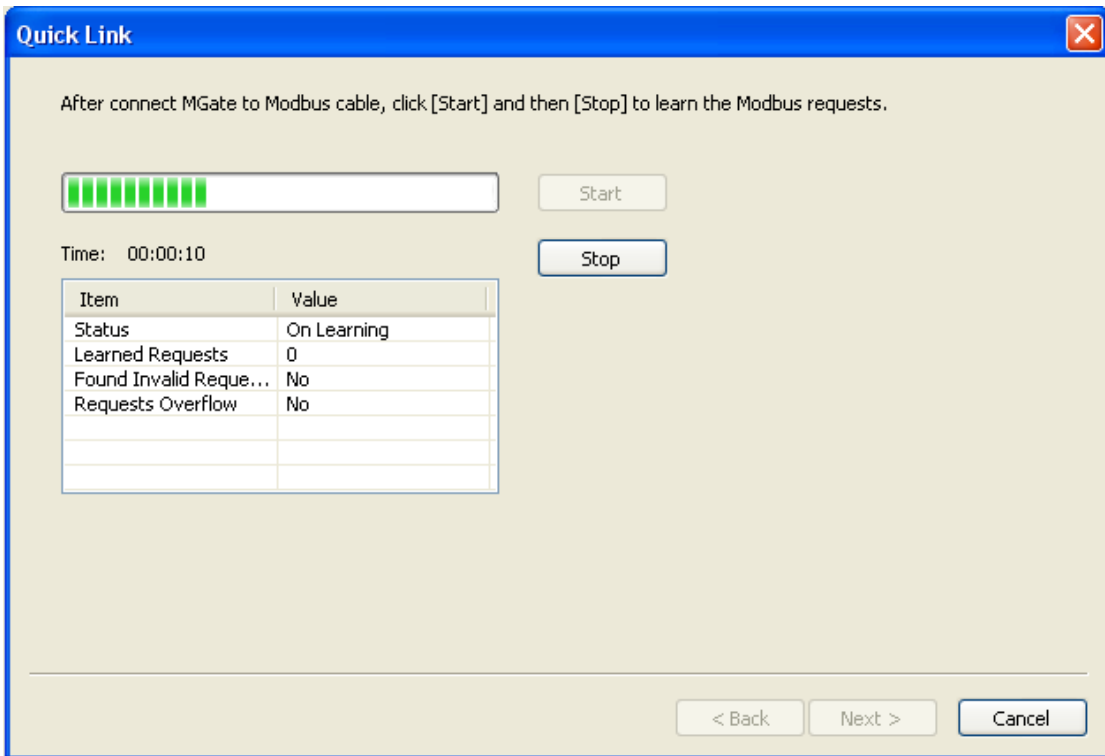

The interface of next dialog is divided into two sections. The upper section is labeled Modbus and will display the details of the Modbus requests which have been learned by the MGate 4101-MB-PBS. The lower section is labeled PROFIBUS Slave and will display the I/O module. Moreover, based on these learned requests, the I/O module blocks are allocated intelligently by MGate Manager. To complete the process, click the **Finish** button to make the settings work.

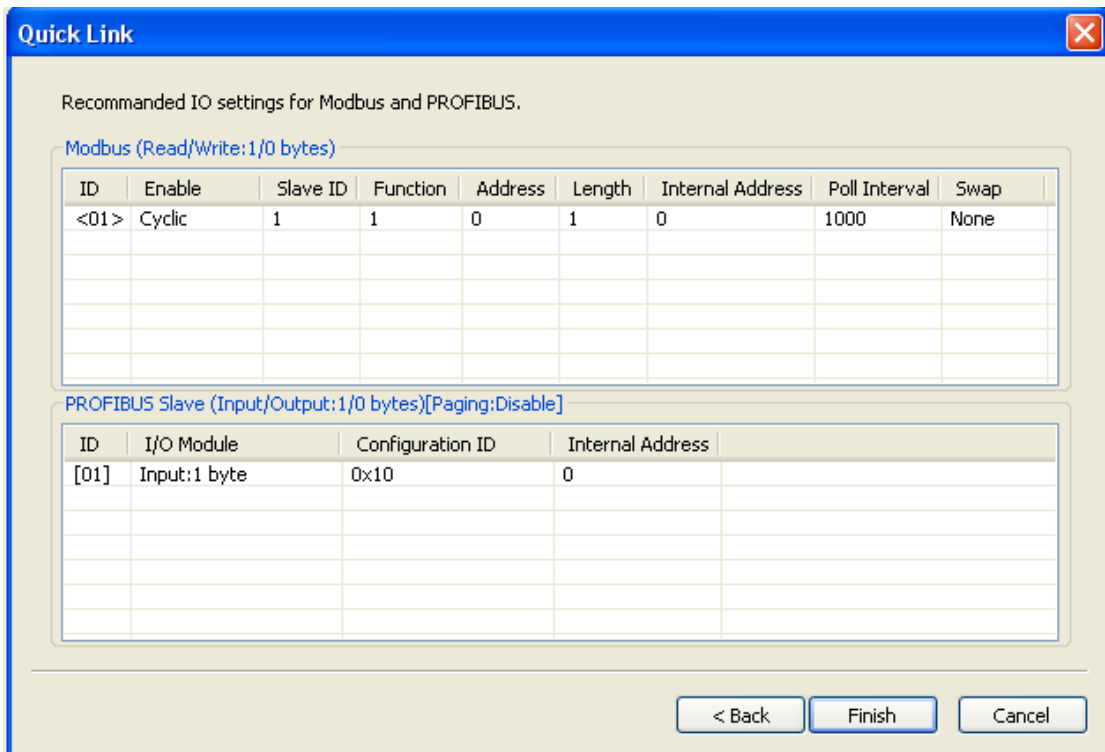

IO Map

The IO Map is a mechanism which is applied when data from different networks are exchanged via the gateway's internal memory, so you must define a memory map in the gateway before starting data exchange. Moreover, two networks access the same memory block in a gateway.

Therefore, gateway internal memory is divided into two blocks. The input memory address starts from 0x00000 and the out memory starts from 0x40000. The following picture demonstrates the memory structure. Each page contains 244 bytes.

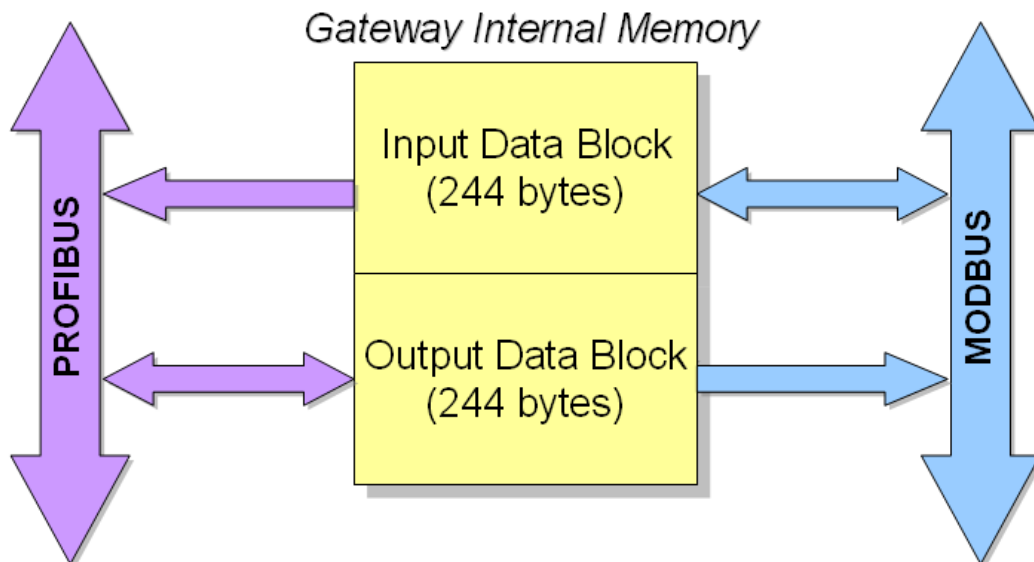

Before data exchange, you first need to map Modbus requests to the I/O module. In troubleshooting, understanding the relationships between the I/O modules and memory is a good way to exclude wrong IO configuration issues. The IO Map function provides a way to check the internal memory address. You can open the IO map dialog with the **IO Map** button.

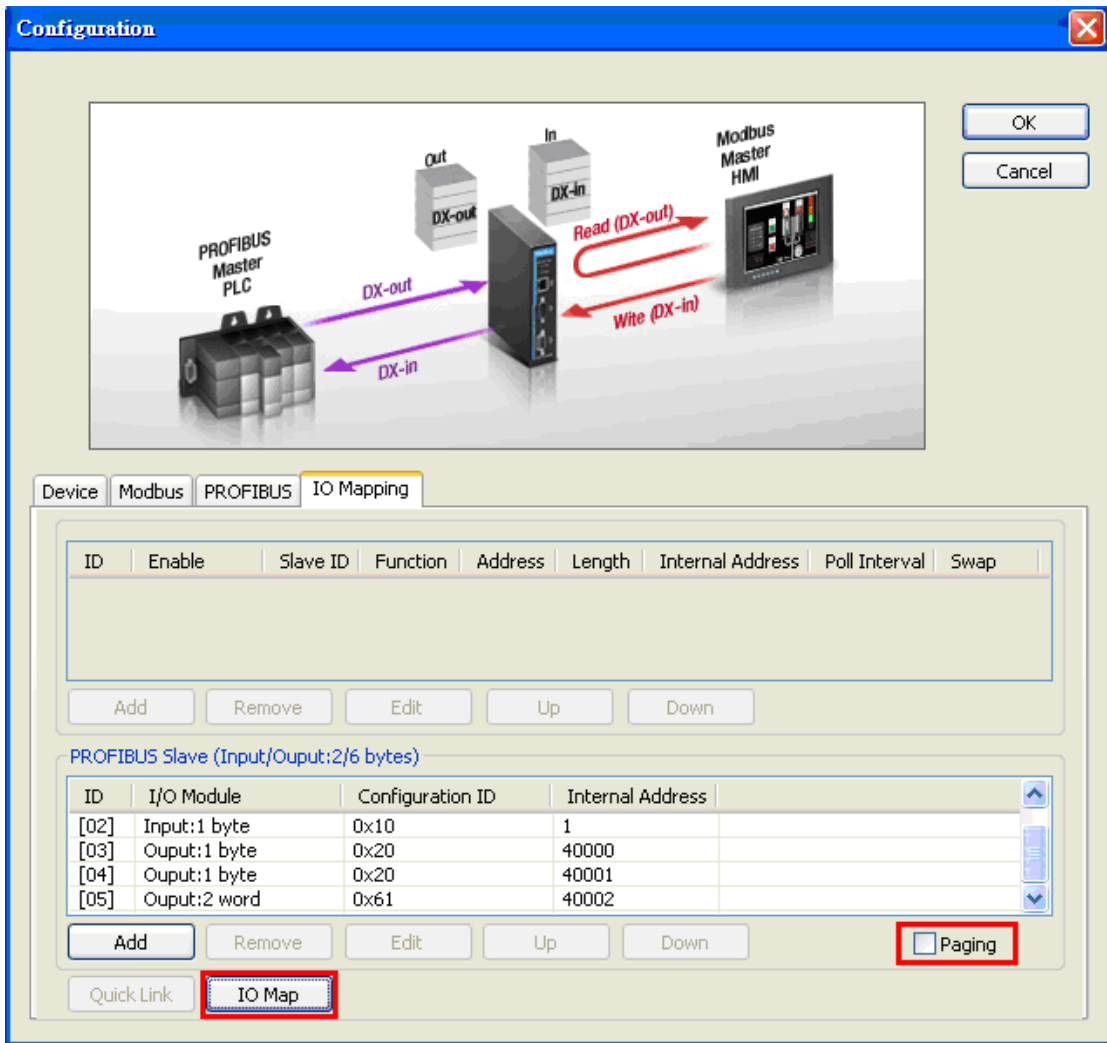

In addition you can select the **Paging** checkbox to enable the page function, so the utility will insert two I/O word modules into the starting location of the input/output memory bank for separate page functionality. Basically, because one I/O module supports 244 bytes only, the paging function can be used to break through this limit. The output I/O module, which is called P1, is used to change the page number to the specified one. The first byte of module P1 attempts to switch input page number and the second byte attempts to change output page number. In addition, the input I/O module, which is called P2, is used to read the current page number. The first byte of module P2 indicates input page number and the second one designates output page number. You can't modify these two I/O modules.

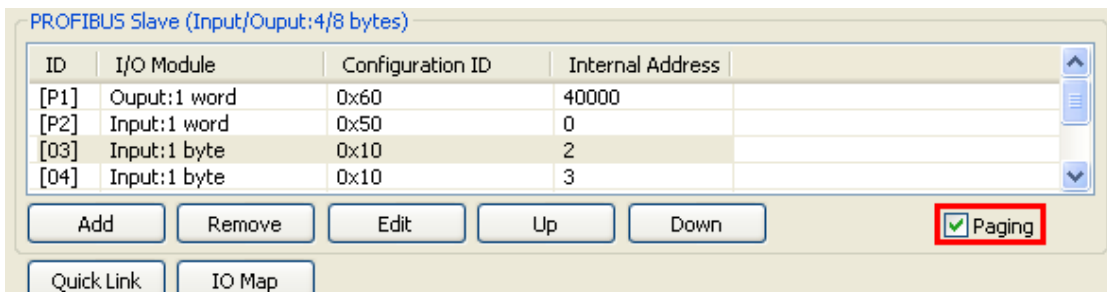

The IO map interface shows input and output memory array. The row unit is internal address and the column unit is byte number. Each column has a length of 20 bytes. Each cell is showed as the following table:

Modbus Mode	Command	The Format Meaning
Master	N/A	<The Modbus ID>[The ID of I/O module]
Slave	05: Write single coil 15: Write multiple coil	<The start bit:The end bit>[The ID of I/O module]
	01: Read coil 02: Read discrete inputs	
Slave	06: Write single register 16: Write multiple register	<The start word>[The ID of I/O module]
	03: Read holding register	
	04: Read input register	

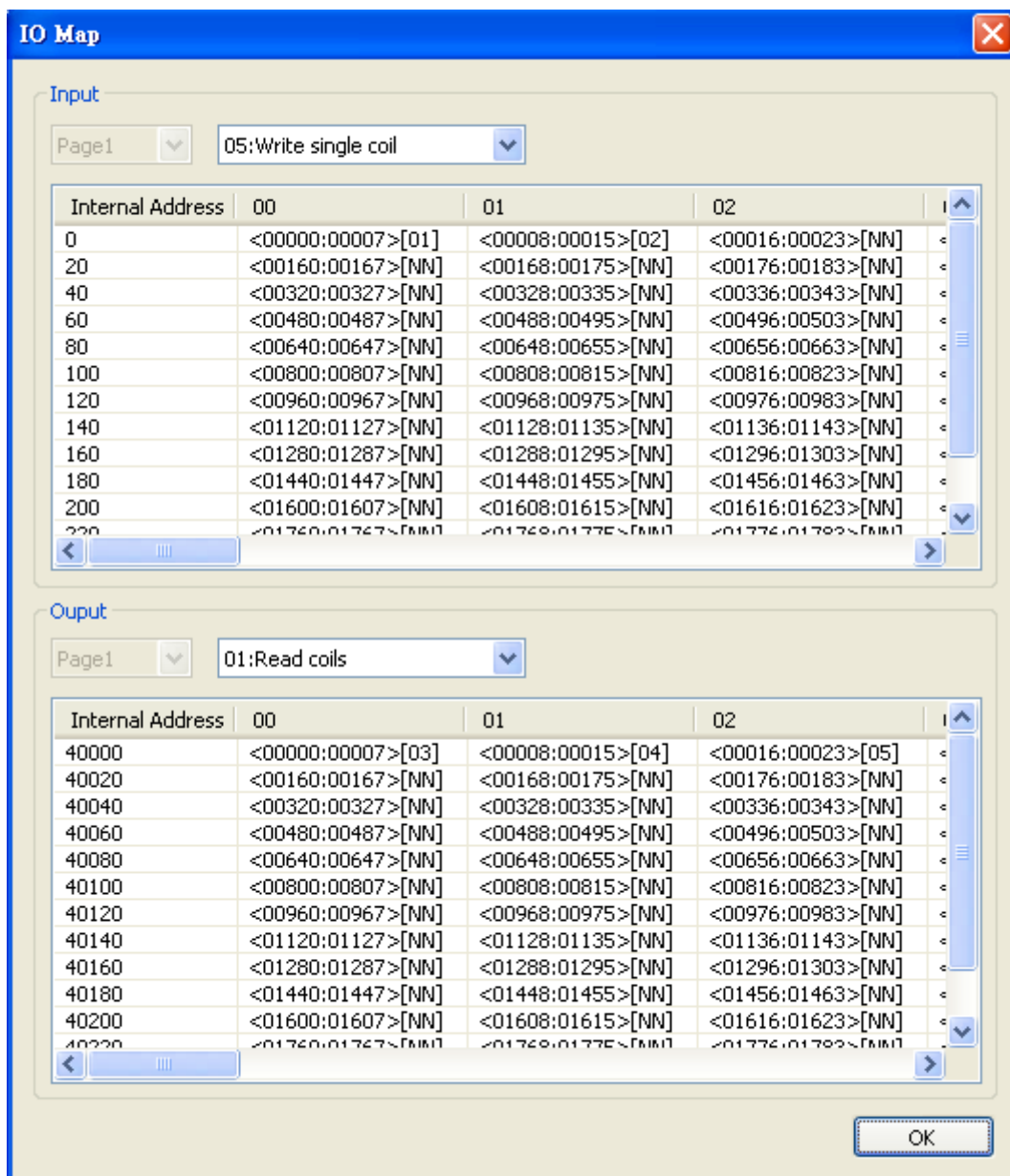

Load Default

If for some reason you would like to clear all the settings of the unit, the **load default** button will reset the unit to its initial factory default values.

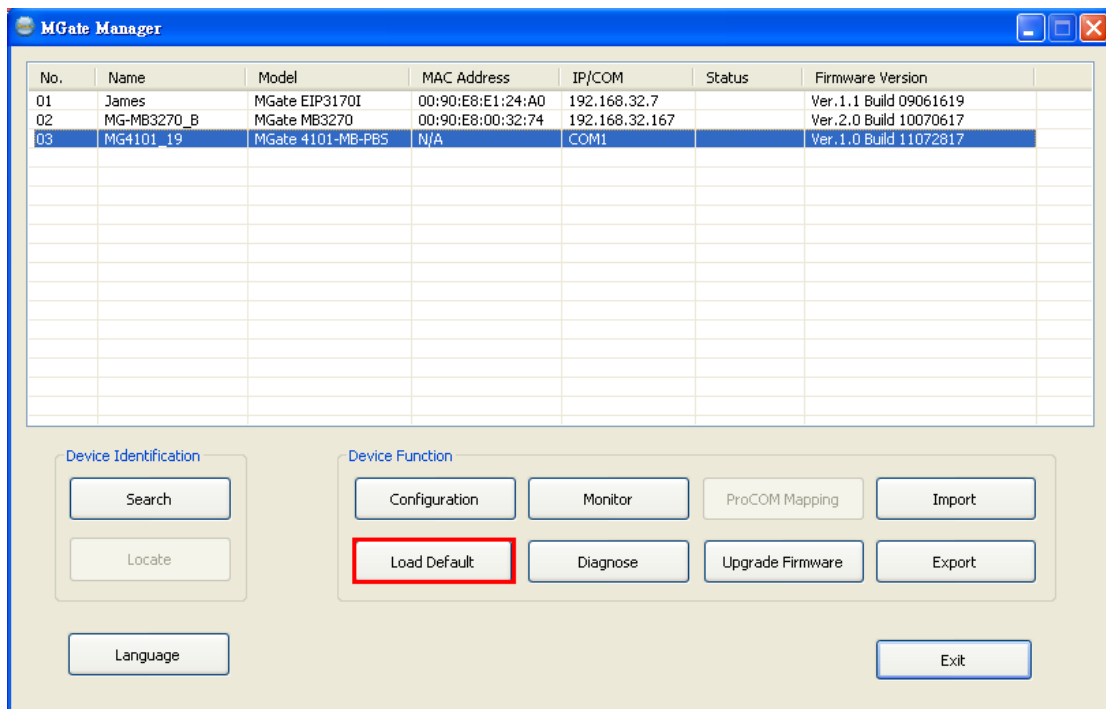

Click Load Default and review the confirmation message. If you are sure you would like to reset the configuration to the factory default, click the **OK** button. If not, click **Cancel**.

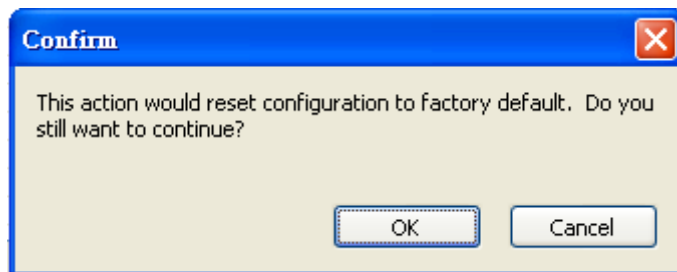

After the MGate Manager resets completely, MGate Manager will automatically execute a Broadcast Search for all MGate units on the LAN and the recording COM port. Your MGate should reappear in the list of units.



ATTENTION

Load Default will completely reset the configuration of the unit, and all of the parameters you have saved will be discarded. Do not use this function unless you are sure you want to completely reset your unit.

Monitoring Modbus Activity

For troubleshooting or management purposes, you can monitor the data passing through any MGate 4101-MB-PBS on the Modbus side. Data events will be logged as they pass through the gateway. Rather than simply echoing the data, MGate Manager presents the data in an intelligent, easily-understood format, with clearly designated fields including source, type, destination, contents, and more. Events can be filtered in different ways, and the complete log can be saved to a file for later analysis.

The screenshot shows the 'Traffic Monitor' application window. At the top right, there are 'Start', 'Stop', and 'Clear' buttons. Below these is a table with the following columns: No., Time, Src. & Dst., Type, Slave ID, Function Code, Data, and Comment. The table contains 26 rows of data, alternating between 'RTU Request' and 'RTU Resp...' types. The 'Data' column shows hexadecimal values like '01 01 01 00 00 01 FD CA' and '01 01 01 00 51 88'. The 'Comment' column consistently says 'Read coils'. At the bottom of the window, there are 'Previous page', 'Next page', 'Load', 'Save', and 'Exit' buttons.

No.	Time	Src. & Dst.	Type	Slave ID	Function Code	Data	Comment
1	0.000	Port1<-	RTU Request	1	1	01 01 01 00 00 01 FD CA	Read coils
2	0.005	Port1->	RTU Resp...	1	1	01 01 01 00 51 88	Read coils
3	1.000	Port1<-	RTU Request	1	1	01 01 01 00 00 01 FD CA	Read coils
4	1.005	Port1->	RTU Resp...	1	1	01 01 01 00 51 88	Read coils
5	2.000	Port1<-	RTU Request	1	1	01 01 01 00 00 01 FD CA	Read coils
6	2.005	Port1->	RTU Resp...	1	1	01 01 01 00 51 88	Read coils
7	3.000	Port1<-	RTU Request	1	1	01 01 01 00 00 01 FD CA	Read coils
8	3.005	Port1->	RTU Resp...	1	1	01 01 01 00 51 88	Read coils
9	4.000	Port1<-	RTU Request	1	1	01 01 01 00 00 01 FD CA	Read coils
10	4.005	Port1->	RTU Resp...	1	1	01 01 01 00 51 88	Read coils
11	5.000	Port1<-	RTU Request	1	1	01 01 01 00 00 01 FD CA	Read coils
12	5.005	Port1->	RTU Resp...	1	1	01 01 01 00 51 88	Read coils
13	6.000	Port1<-	RTU Request	1	1	01 01 01 00 00 01 FD CA	Read coils
14	6.005	Port1->	RTU Resp...	1	1	01 01 01 00 51 88	Read coils
15	7.000	Port1<-	RTU Request	1	1	01 01 01 00 00 01 FD CA	Read coils
16	7.005	Port1->	RTU Resp...	1	1	01 01 01 00 51 88	Read coils
17	8.000	Port1<-	RTU Request	1	1	01 01 01 00 00 01 FD CA	Read coils
18	8.005	Port1->	RTU Resp...	1	1	01 01 01 00 51 88	Read coils
19	9.000	Port1<-	RTU Request	1	1	01 01 01 00 00 01 FD CA	Read coils
20	9.005	Port1->	RTU Resp...	1	1	01 01 01 00 51 88	Read coils
21	10.000	Port1<-	RTU Request	1	1	01 01 01 00 00 01 FD CA	Read coils
22	10.005	Port1->	RTU Resp...	1	1	01 01 01 00 51 88	Read coils
23	11.000	Port1<-	RTU Request	1	1	01 01 01 00 00 01 FD CA	Read coils
24	11.005	Port1->	RTU Resp...	1	1	01 01 01 00 51 88	Read coils
25	12.000	Port1<-	RTU Request	1	1	01 01 01 00 00 01 FD CA	Read coils
26	12.005	Port1->	RTU Resp...	1	1	01 01 01 00 51 88	Read coils

Open Traffic Monitor Window

Select the unit that you wish to monitor and click **Monitor** to open the Traffic Monitor window.

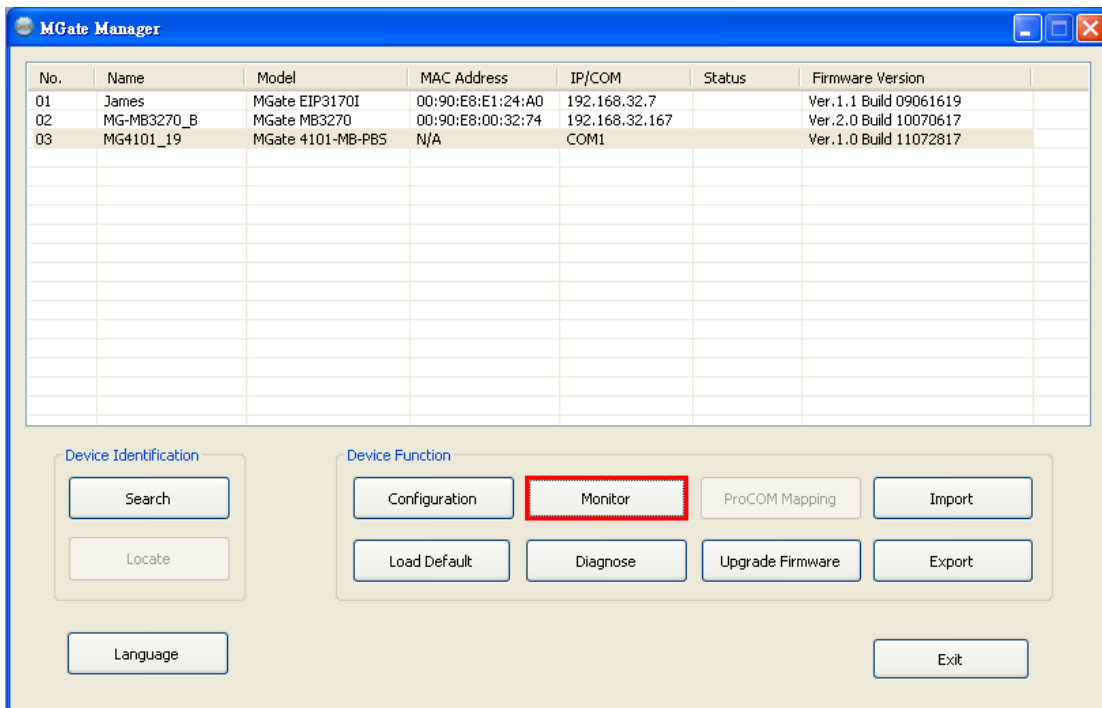

In the Traffic Monitor window, click **Start** to begin live monitoring of the data passing through the selected MGate 4101-MB-PBS unit.

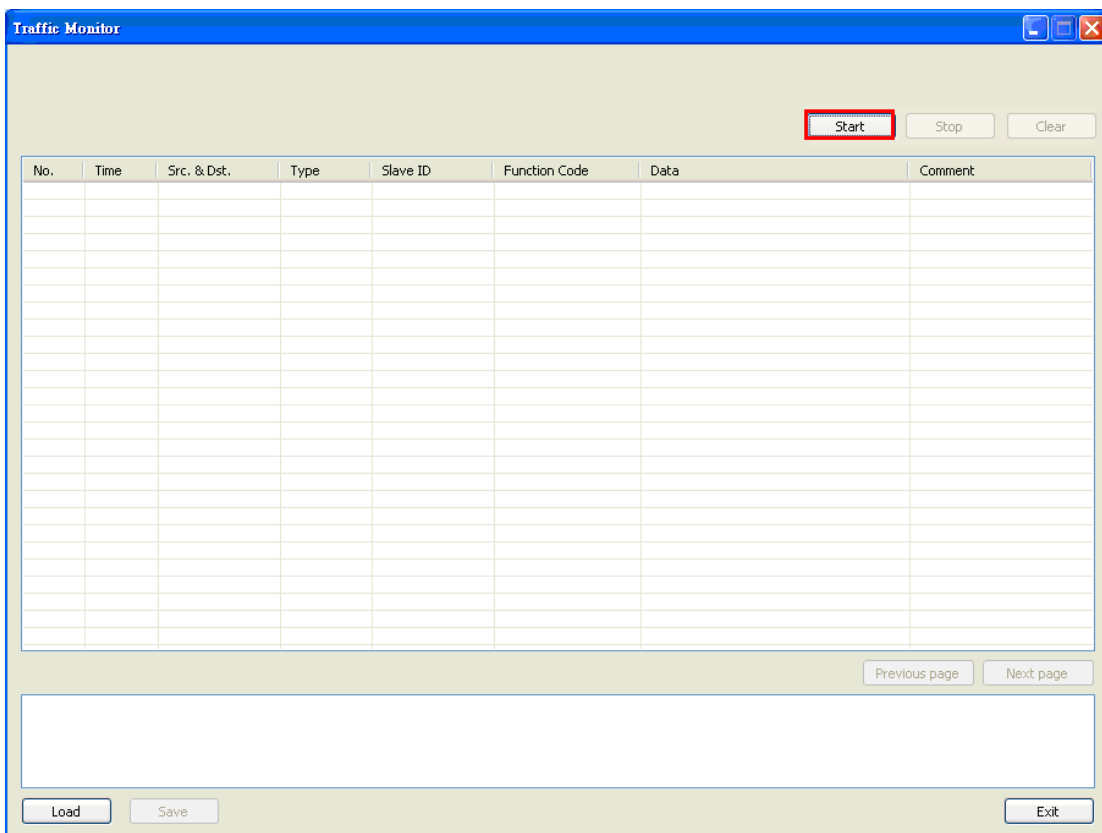

To stop capturing the log, press the **Stop** button.

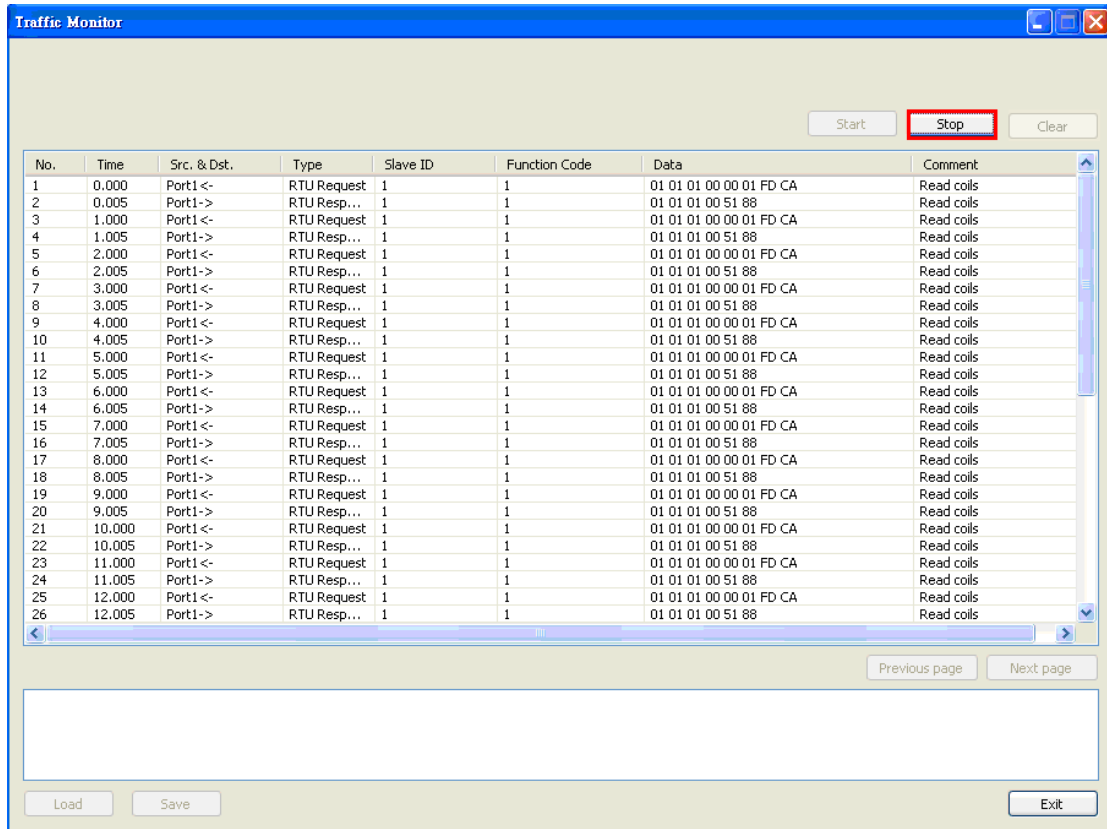

Save Log to File

To save the data log to a file, click **Save**. You may retrieve a saved log by clicking **Load**.

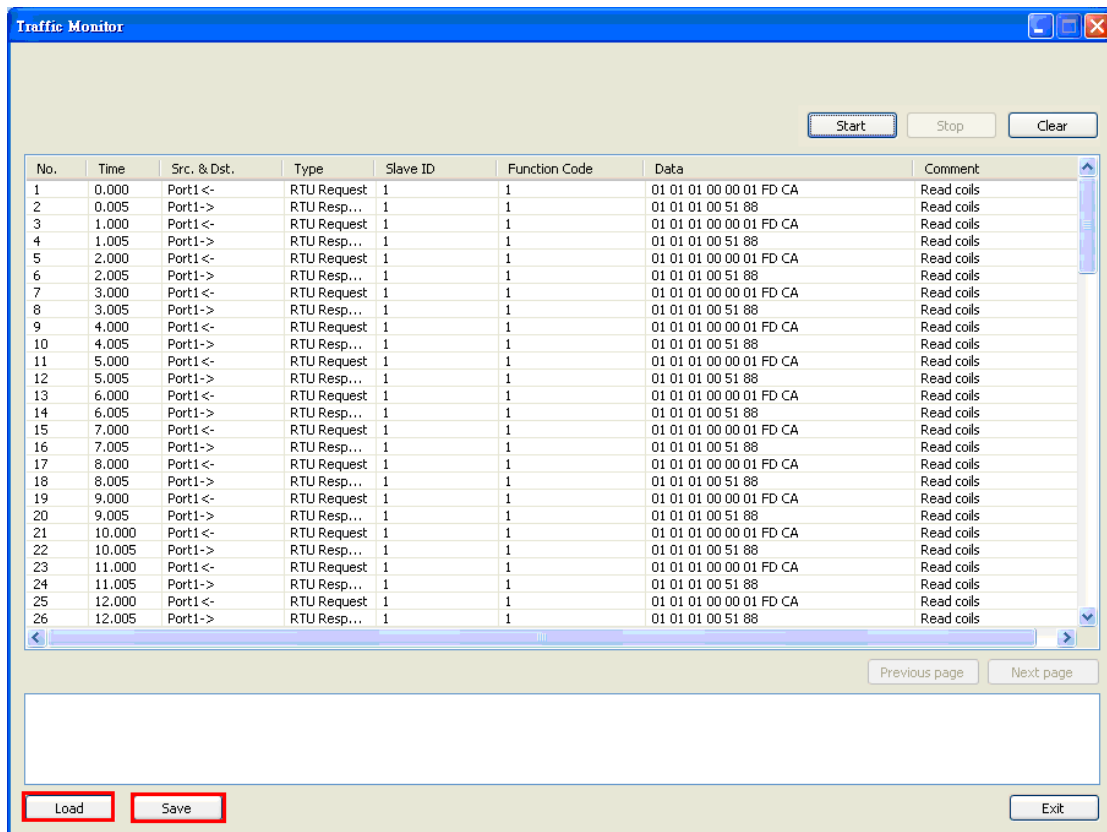

Diagnose

Diagnose is a powerful function to identify communications problems and assist in troubleshooting when setting up a PROFIBUS and Modbus environment. Select the desired unit from the list in MGate Manager and click **Diagnose** to check the communication status.

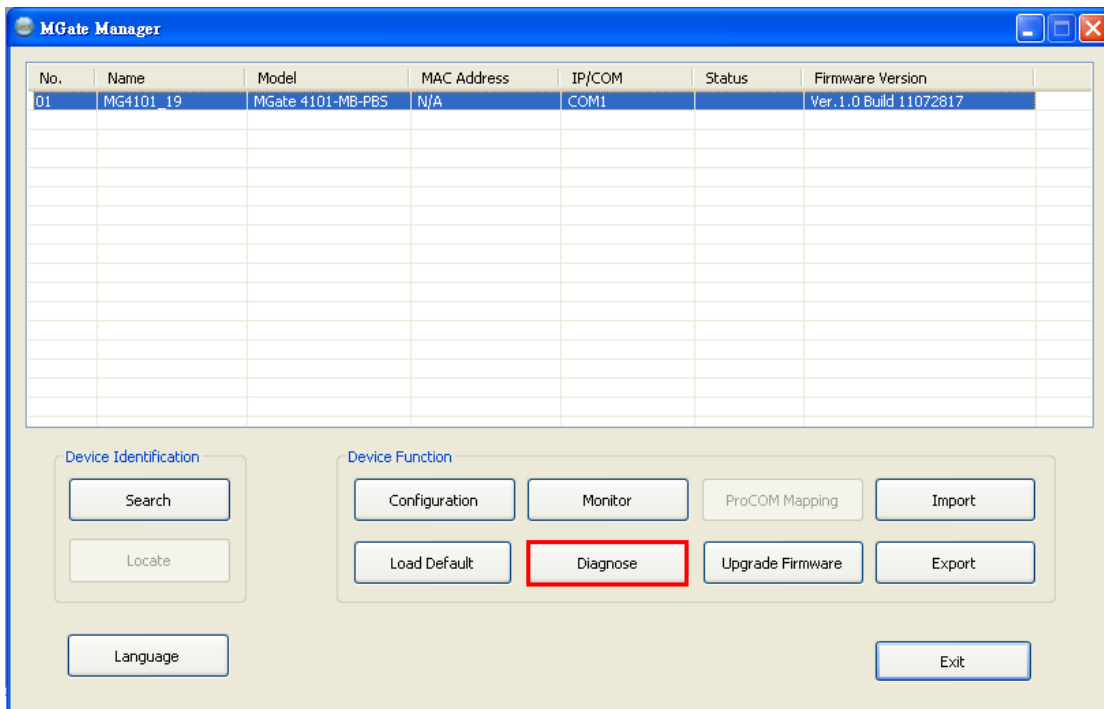

The dialog box will show the detailed of communication status of both Modbus and PROFIBUS, in addition it contains serial parameters.

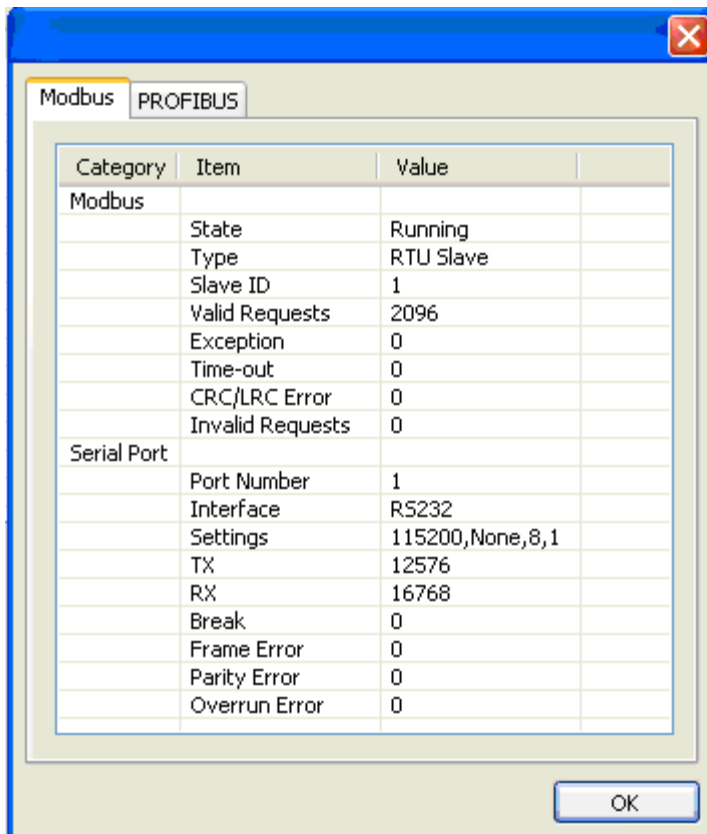

There are two parts. In Modbus tab, the first part is the information regarding Modbus. These details will help you to analyze the Modbus communication.

Modbus	Description
State	The communication state of Modbus side
Type	RTU Slave / RTU Master / ASCII Slave / ASCII Master
Slave ID	The Slave ID for Modbus
Valid Requests	The number of valid requests
Exception	The number of exceptions
Time-out	The number of time-outs
CRC/LRC Error	The number of CRC/LRC errors
Invalid Requests	The number of invalid requests

The second part is the serial parameters. It includes the serial communication about this serial port

Serial Port	Description
Port Number	The serial port number
Interface	The serial interface, RS-232/RS-422/RS-485-2w/RS-485-4w
Settings	The parameter includes baudrate, parity, start bit and stop bit, for example, 19200, None, 8, 1
Tx	The transmission count
Rx	The receive count
Break	The number of break signals
Frame Error	The number of frame errors
Parity Error	The number of parity errors
Overrun Error	The number of overrun errors

The PROFIBUS tab has information about the PROFIBUS status

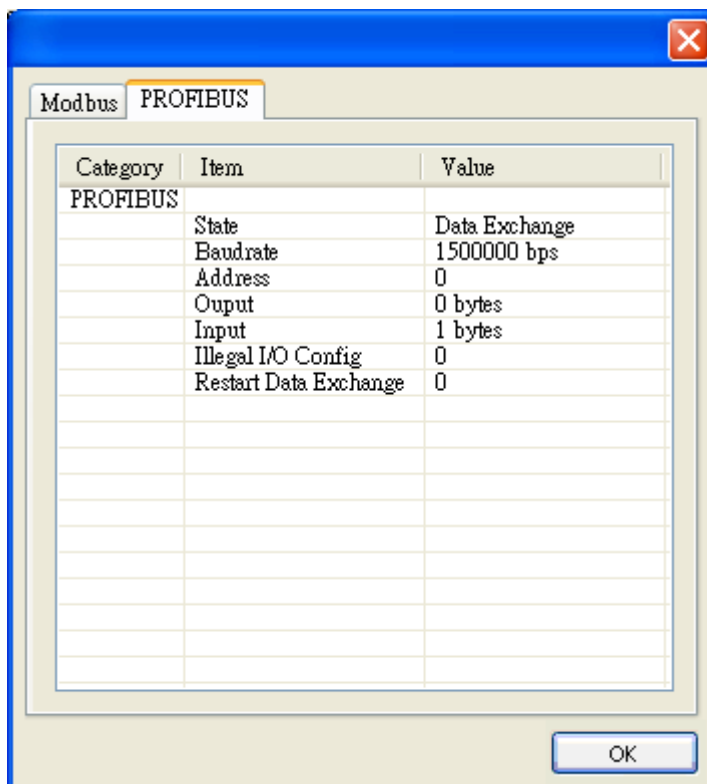

PROFIBUS	Description
State	The communication state of PROFIBUS side
Baudrate	The baudrate of PROFIBUS side
Address	The PROFIBUS segment ID

Output	The output bytes
Input	The input bytes
Illegal I/O Config	The number of illegal I/O configs
Restart Data Exchange	The number of restarted data exchanges

Upgrading Firmware

Firmware updates for the MGate 4101-MB-PBS are located at www.moxa.com. After you have downloaded the new firmware onto your PC, you can use MGate Manager to write it onto your MGate 4101-MB-PBS. Select the desired unit from the list in MGate Manager and click **Upgrade Firmware** to begin the process.

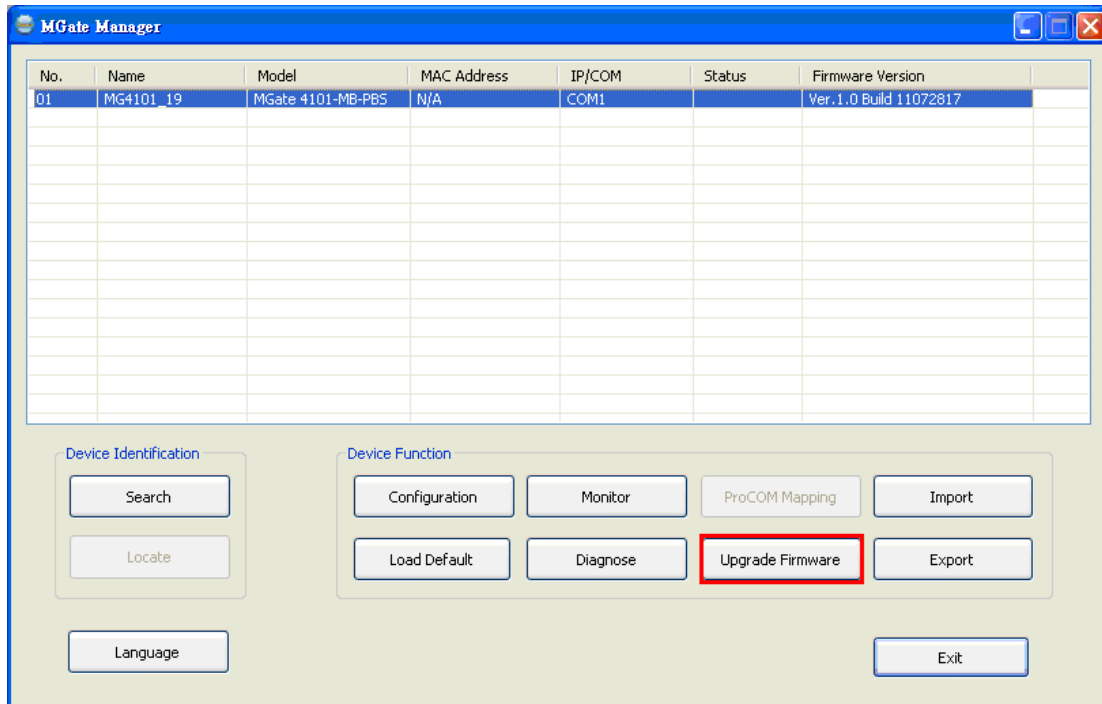

The dialog boxes will guide you through the process. You will need to browse your PC for the firmware file. Make sure that it matches your model.

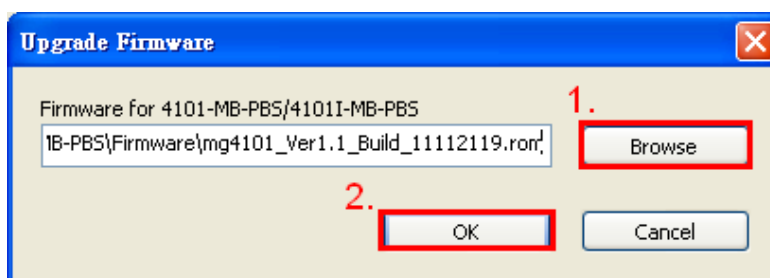

As the firmware is written to the unit, progress is displayed in the window.

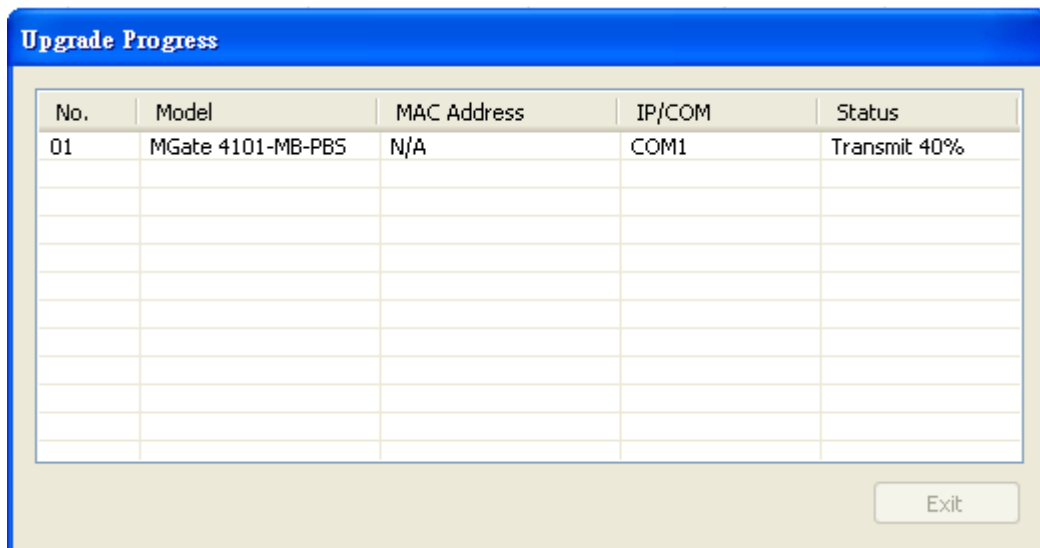

Once the firmware has been successfully written onto the unit, click **Exit** to close the Upgrade Firmware window. MGate Manager will automatically execute a Broadcast Search for all MGate units on the LAN and the recording COM port. Your MGate should reappear in the list of units.

Import/Export

The Import/Export configuration function is a convenient way to apply the same settings to units which are located in different sites. You can export the configuration as a file, and then import that configuration file onto other units at any time.

The export function saves all the configuration settings and parameters of the MGate 4101-MB-PBS will be saved in an .ini file. To begin, click the **Export** button.

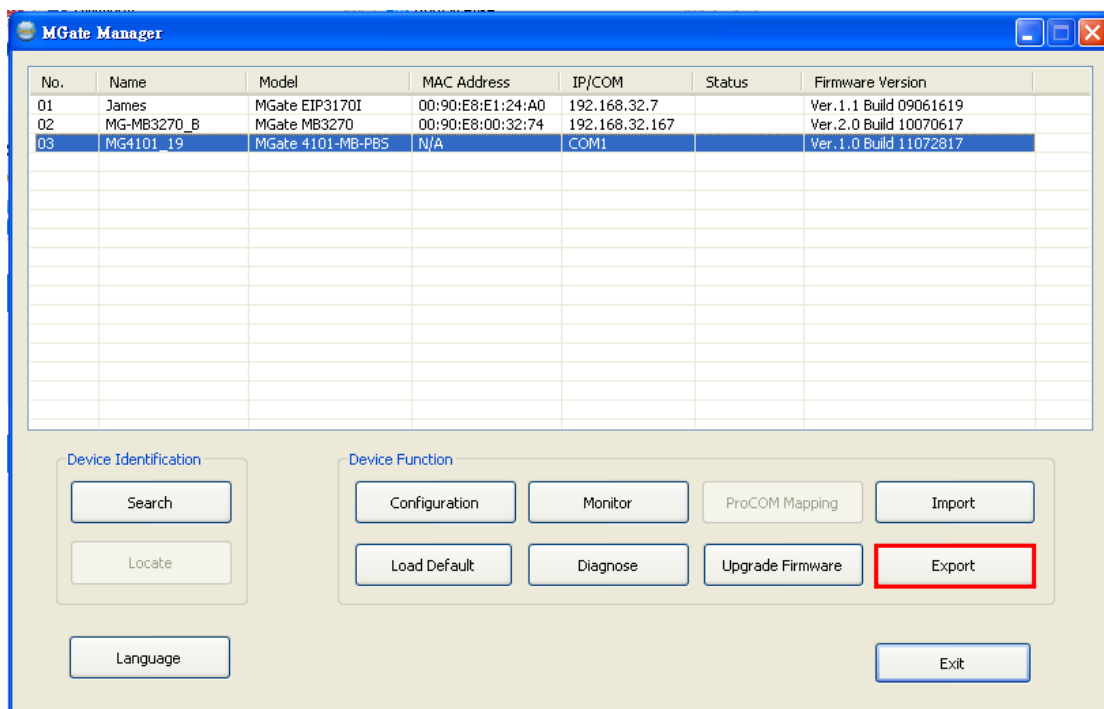

Type in a file name and use the **Browse** button to set the save file to a specific path. Then, click the **OK** button.

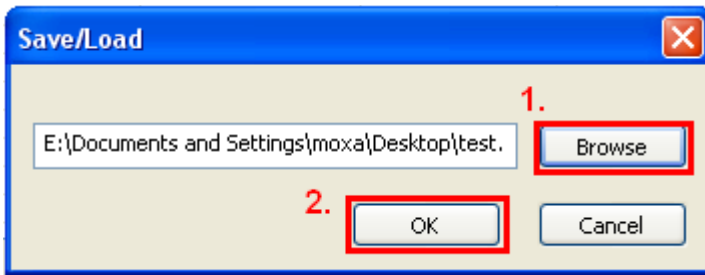

If you export the configuration file successfully, a confirmation message will pop up.



After that, the configuration file will be saved as an .ini file



Once the file is saved, it can be imported into your target unit to duplicate the same settings. Select the target unit first and click the **Import** button to import.

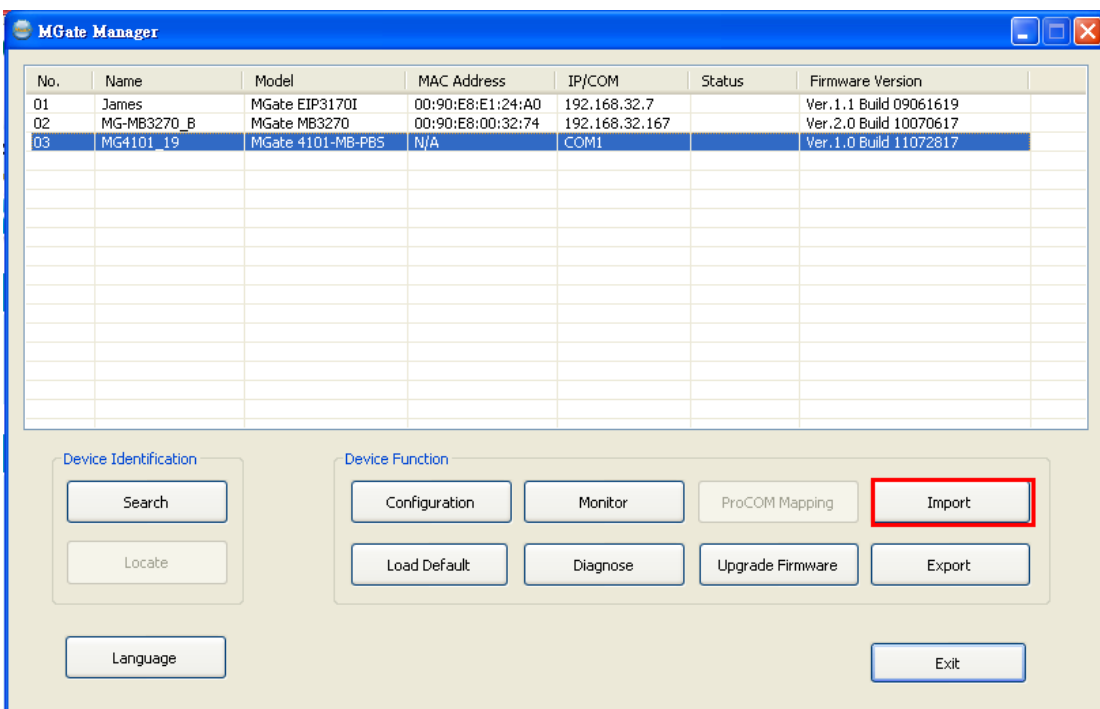

Select the file you want to import, then click the **OK** button

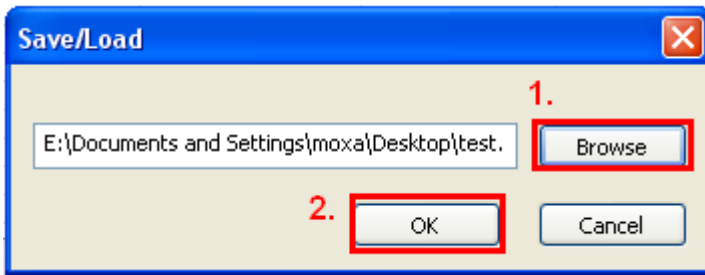

Please be patient and wait as MGate Manager configures the target device.

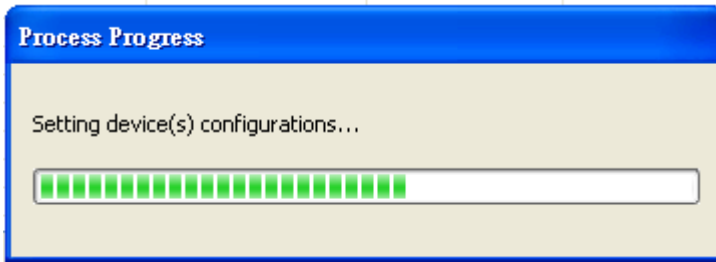

If you import the configuration file successfully, a confirmation message will pop up.



After closing the message dialog, MGate Manager will automatically execute a Broadcast Search for all MGate units on the LAN and the recording COM port. Your MGate should reappear in the list of units.

A

Quick Configuration

The following topics are covered in this appendix:

- **Typical Applications**
- **Quick Configuration Steps**
- **PROFIBUS Overview**
- **Modbus Overview**
- **Diagnose Packet Format**

Typical Applications

Here is a typical application to demonstrate how to use the Quick Link function and explain how QuickLink works.

First of all, we are assuming there is a legacy Modbus master in the original application and the Modbus master is running. After MGate 4101-MB-PBS connects to Modbus master, the MGate 4101-MB-PBS acts as a Modbus slave to learn Modbus requests from the master automatically.

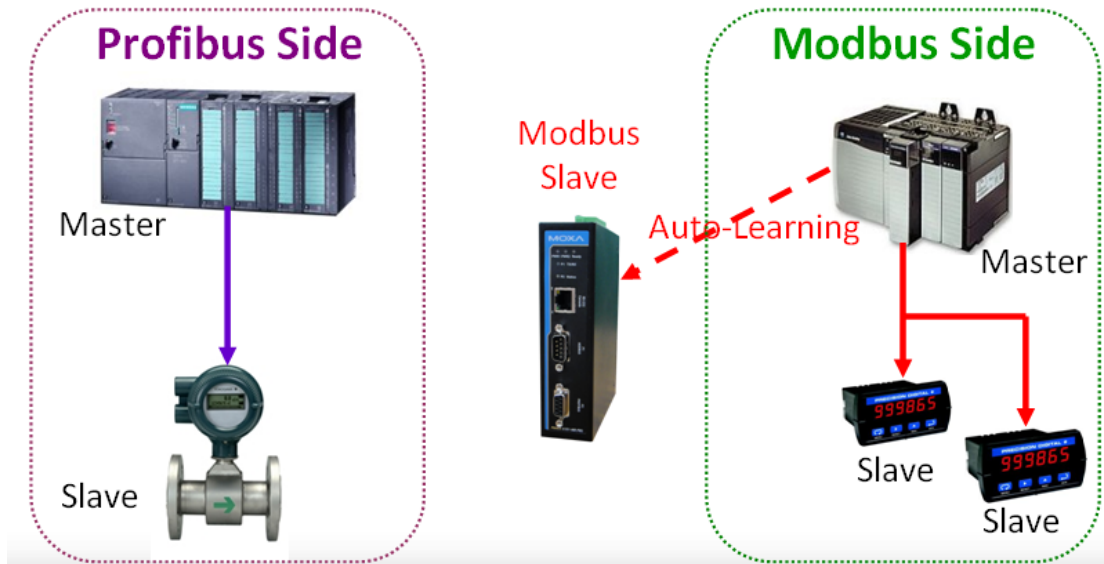

After some time, MGate 4101-MB-PBS will fully learn the requests from the Modbus master. Through this QuickLink process, the MGate 4101-MB-PBS can replace the legacy Modbus master. Moreover, the MGate 4101-MB-PBS can respond to all of the Modbus slaves correctly.

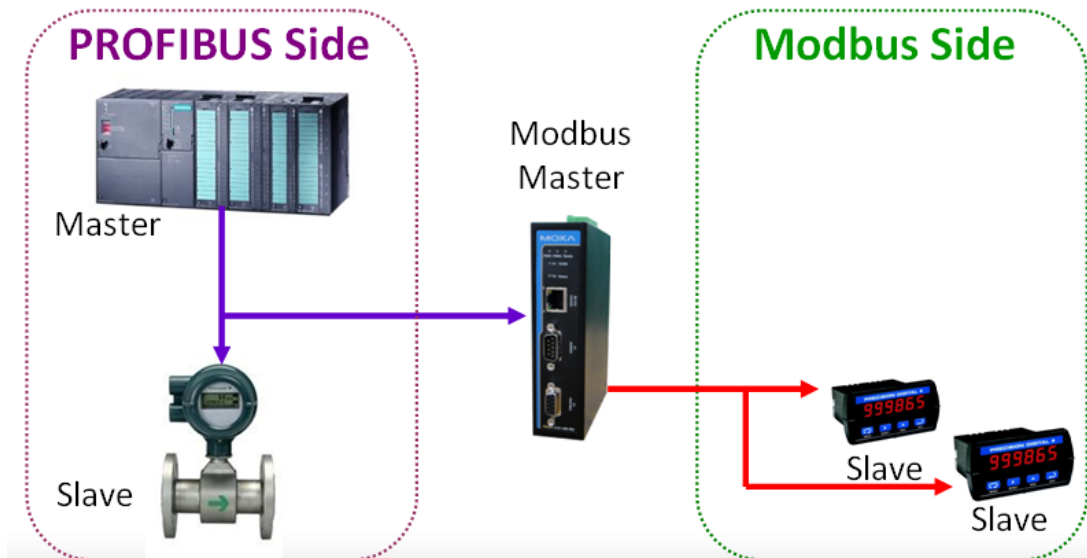

NOTE QuickLink is enabled with the MGate 4101-MB-PBS is in master mode only. Please set the MGate 4101-MB-PBS in master mode before you use the QuickLink function.

Quick Configuration Steps

MGate 4101-MB-PBS provides an innovative function which can automatically and quickly finish the configuration. Two typical architectures are illustrated below. Confirm which architecture is used in your application and then follow the steps to finish the configuration.

MGate 4101 is Modbus Master

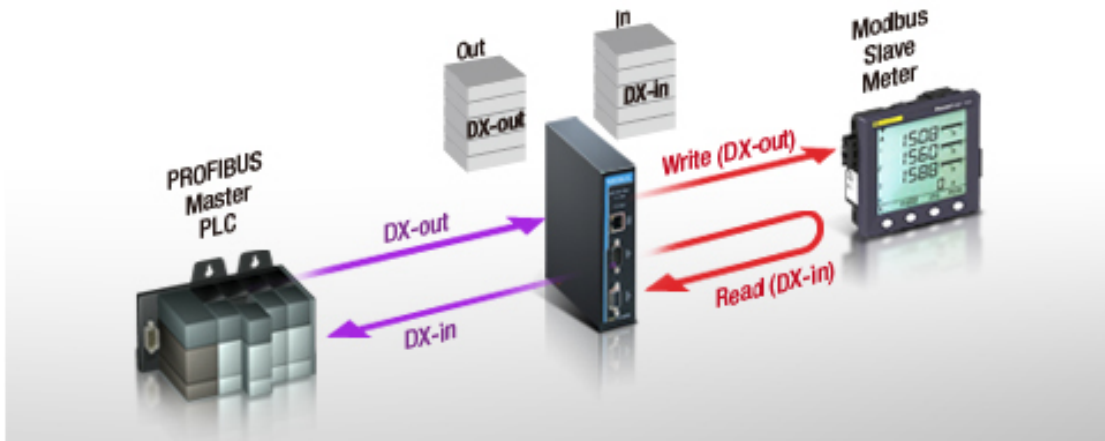

MGate 4101 is Modbus Slave

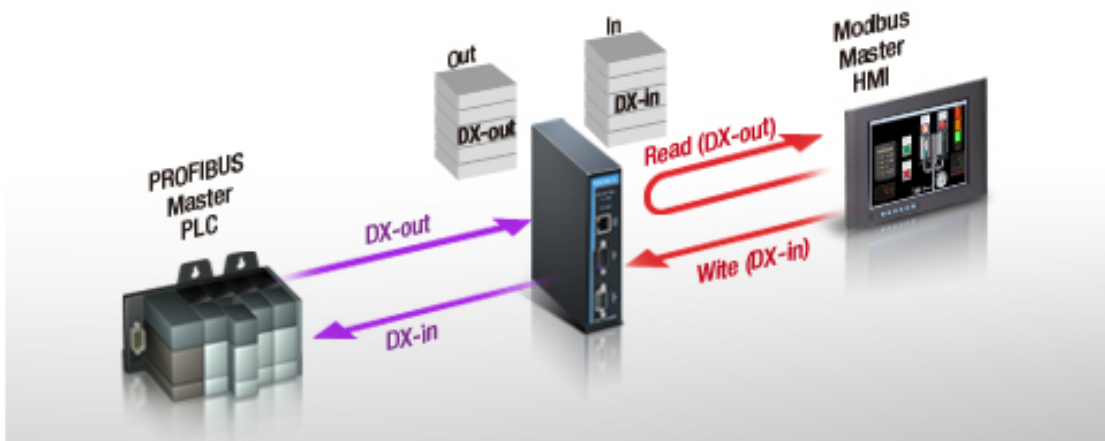

PROFIBUS Overview

Introduction

PROFIBUS (Process Field Bus) is a standard for field bus communication in automation technology and was first promoted in 1989 by BMBF (German department of education and research).

Topology

PROFIBUS uses the bus topology. In this topology, a central line, or bus, is wired throughout the system. Devices are attached to this central bus. One bus eliminates the need for a full-length line going from the central controller to each individual device.

In the past, each PROFIBUS device had to connect directly to the central bus. Technological advancements, however, have made it possible for a new "two-wire" system. In this way, multiple PROFIBUS buses can connect to each other.

MGate 4101-MB-PBS

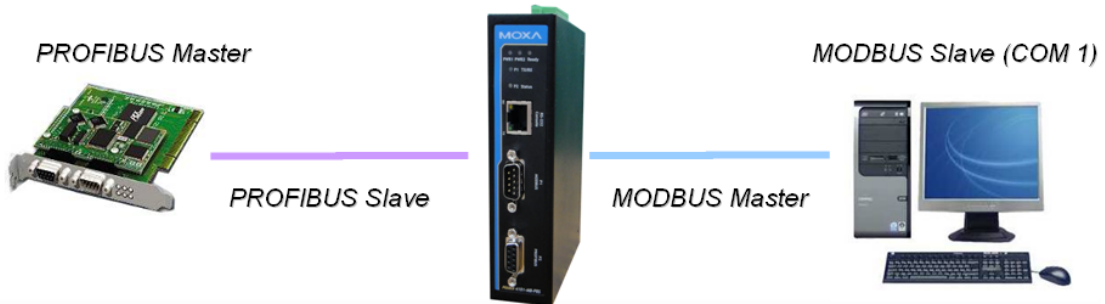

Modbus Overview

Introduction

Modbus is one of the most popular automation protocols in the world. It supports both serial and Ethernet devices. Many industrial devices, such as PLCs, DCSs, HMIs, instruments, meters, motors, and drivers, use Modbus as their communication standard.

Devices are Either Masters or Slaves

All Modbus devices are classified as either a master or a slave. Masters initiate all communication with slaves and do not communicate to other masters. Slaves are completely passive and communicate only by sending a response to a master's request.

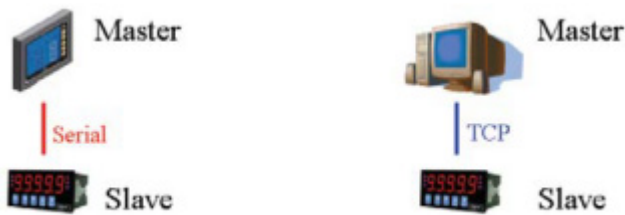

Slaves are Identified by ID

Each Modbus slave in a system is assigned a unique ID between 1 and 247. Whenever a master makes a request, the request must include the ID of the intended recipient. Master devices themselves have no ID.

0	1~247	248~255
Broadcast address	Slave individual address	Reserved

Communication is by Request and Response

All Modbus communication is by request and response. A master sends a request and a slave sends a response. The master will wait for the slave's response before sending the next request. For broadcast commands, no response is expected. This is illustrated by three scenarios as follows:

Normal

The master sends a request to the slave. The slave sends a response with the requested information.

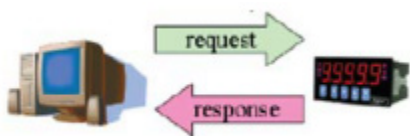

Exception

The master sends a request to the slave. The slave may not support the command or an error is detected, so it sends an exception to the master.

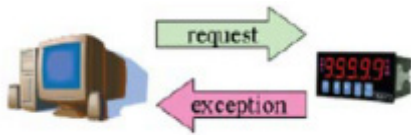

Broadcast

The master sends a broadcast command, such as a reset command. Every slave on the network complies with the command, and no response is sent to the master.

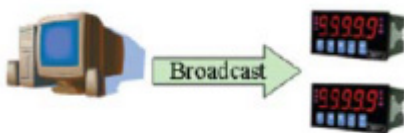

Requests Need a Time Limit

The original Modbus protocol was not designed for simultaneous requests or simultaneous masters, so only one request on the network can be handled at a time. When a master sends a request to a slave, no other communication may be initiated until after the slave responds. The Modbus protocol specifies that masters use a response timeout function to identify when a slave is nonresponsive due to device or line failure. This function allows a master to give up on a request if no response is received within a certain amount of time. This is illustrated as follows:

Response Timeout

The master sends a request. The slave is unresponsive for the amount of time specified by the response timeout function. The master gives up on the request and resumes operation, allowing another request to be initiated.



To allow for a wide range of devices, baudrates, and line conditions, actual response timeout values are left open for manufacturers to determine. This allows the Modbus protocol to accommodate a wide range of devices and systems. However, this also makes it difficult for system integrators to know what response timeout value to use during configuration, specially with older or proprietary devices.

The MGate MB3000 provides a patent-pending function that tests all attached devices and recommends a response timeout value. This function saves considerable time and effort for system integrators, and results in more accurate timeout settings.

Modbus Ethernet vs. Modbus Serial

Although Modbus is intended as an application layer messaging protocol, the data format and communication rules for Ethernet-based Modbus TCP are different from serial-based Modbus ASCII and RTU.

The major difference between the Ethernet and serial Modbus protocols is the behavior of the communication model. Modbus ASCII and RTU allow only one request on the network at a time. Once a request is sent, no other communication on the bus is allowed until the slave sends a response, or until the request times out. However, Modbus TCP allows simultaneous requests on the network, from multiple masters to multiple slaves. TCP masters cannot send more than one request at a time to a slave, but they can send requests to other slaves before a response is received. The Modbus TCP standard recommends that slaves be able to queue up to 16 requests at a time. The MGate MB3000 will queue up to 32 requests from each TCP master, for up to 16 TCP masters.

Integrate Modbus Serial and Ethernet with Gateways

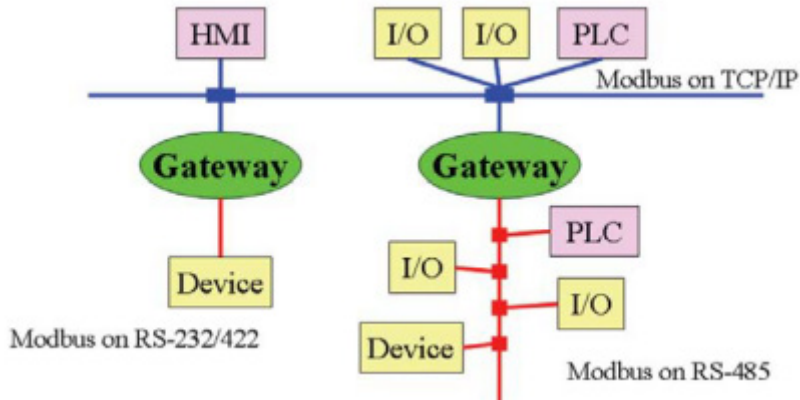

Ordinarily, Modbus TCP and Modbus ASCII/RTU are unable to communicate with each other.

However, with a Modbus gateway in between the Modbus serial network and the Modbus Ethernet network, TCP masters are able to communicate with serial slaves and serial masters are able to communicate with TCP slaves.

Diagnose Packet Format

When the communication of MGate works well between PROFIBUS and Modbus protocols, MGate won't go into diagnostic mode. However, if there is an error in the Modbus connection, for example, a disconnection or no responses, the MGate will continue to send polling requests until three requests are sent without response. Then, it will enter diagnostic mode. In this mode, the MGate will send diagnose packets periodically. Upon receiving the correct response, MGate will go back to normal operations.

Refer to the diagnose packet format table to help identify why the MGate entered diagnostic mode.

Byte	Parameter	Notes
1	Length	The length of diagnose packet
2	Page number	The paging number which the problem data locates
3	Module	The PROFIBUS IO module number which the problem data locates

For instance, if the diagnose packet is 03 01 03, that means the problem data is located on the third PROFIBUS IO module in page one. Using this information, you can check if the location of the internal memory is correct.